



**ADLINK**  
TECHNOLOGY INC.

# PXle-3935

## PXle Express Embedded Controller

### User's Manual



**Manual Rev.:** 2.00  
**Revision Date:** Mar. 24, 2017  
**Part No:** 50-17052-1000

**Advance Technologies; Automate the World.**

# Revision History

Revision	Release Date	Description of Change(s)
2.00	2017/3/24	Initial Release

# Preface

## **Copyright 2017 ADLINK TECHNOLOGY, INC.**

This document contains proprietary information protected by copyright. All rights are reserved. No part of this manual may be reproduced by any mechanical, electronic, or other means in any form without prior written permission of the manufacturer.

## **Disclaimer**

The information in this document is subject to change without prior notice in order to improve reliability, design, and function and does not represent a commitment on the part of the manufacturer.

In no event will the manufacturer be liable for direct, indirect, special, incidental, or consequential damages arising out of the use or inability to use the product or documentation, even if advised of the possibility of such damages.

## **Environmental Responsibility**

ADLINK is committed to fulfill its social responsibility to global environmental preservation through compliance with the European Union's Restriction of Hazardous Substances (RoHS) directive and Waste Electrical and Electronic Equipment (WEEE) directive. Environmental protection is a top priority for ADLINK. We have enforced measures to ensure that our products, manufacturing processes, components, and raw materials have as little impact on the environment as possible. When products are at their end of life, our customers are encouraged to dispose of them in accordance with the product disposal and/or recovery programs prescribed by their nation or company.

Product names mentioned herein are used for identification purposes only and may be trademarks and/or registered trademarks of their respective companies.

## Conventions

Take note of the following conventions used throughout this manual to make sure that users perform certain tasks and instructions properly.



NOTE:

Additional information, aids, and tips that help users perform tasks.

---



CAUTION:

Information to prevent **minor** physical injury, component damage, data loss, and/or program corruption when trying to complete a task.

---



WARNING:

Information to prevent **serious** physical injury, component damage, data loss, and/or program corruption when trying to complete a specific task.

---

# Table of Contents

<b>Revision History</b> .....	<b>ii</b>
<b>Preface</b> .....	<b>iii</b>
<b>List of Figures</b> .....	<b>vii</b>
<b>List of Tables</b> .....	<b>ix</b>
<b>1 Introduction</b> .....	<b>1</b>
1.1 Features.....	2
1.2 Specifications.....	3
1.3 Front Panel I/O & Indicators .....	7
1.3.1 PXIe Trigger Connector.....	8
1.3.2 DisplayPort Connectors.....	9
1.3.3 GPIB Connector .....	10
1.3.4 Reset Button.....	11
1.3.5 LED Indicators .....	11
1.3.6 USB 2.0 Ports.....	12
1.3.7 Gigabit Ethernet Ports .....	13
1.3.8 COM Port.....	14
1.3.9 USB 3.0 Ports.....	15
1.3.10 Onboard Connections and Settings.....	16
<b>2 Getting Started</b> .....	<b>17</b>
2.1 Package Contents .....	17
2.2 Operating System Installation.....	17
2.2.1 Driver Installation.....	19
2.2.2 Installation Environment .....	19
2.2.3 Installing the PXIe-3935 .....	21
2.2.4 Replacing the Hard Drive or Solid State Drive .....	22
2.2.5 Replacing the Battery Backup .....	23

2.2.6	Clearing CMOS.....	23
2.2.7	Initiating Backup BIOS Flash.....	24
<b>A</b>	<b>Appendix: PXIe Trigger I/O Function Reference.....</b>	<b>25</b>
A.1	Data Types.....	25
A.2	Function Library.....	26
A.2.1	TRIG_Init.....	26
A.2.2	TRIG_Close.....	27
A.2.3	TRIG_SetSoftTrg.....	27
A.2.4	TRIG_Trigger_Route.....	28
A.2.5	TRIG_Trigger_Clear.....	30
A.2.6	TRIG_GetSoftTrg.....	31
A.2.7	TRIG_Trigger_Route_Query.....	31
A.2.8	TRIG_GetDriverRevision.....	33
<b>B</b>	<b>Appendix: BIOS Setup.....</b>	<b>35</b>
B.1	Starting the BIOS.....	35
B.2	Main Setup.....	37
B.3	Advanced Setup.....	37
B.4	Boot Setup.....	38
B.5	Security Setup.....	38
B.6	Save & Exit Setup.....	39
	<b>Important Safety Instructions.....</b>	<b>41</b>
	<b>Getting Service.....</b>	<b>45</b>

# List of Figures

Figure 1-1: PXle-3935 Functional Block Diagram.....	3
Figure 1-2: Front Panel .....	7
Figure 1-3: PXle Trigger SMB Jack .....	8
Figure 1-4: LED Indicators .....	11
Figure 1-5: COM Port.....	14
Figure 1-6: PXle-3985 Onboard Configuration .....	16

This page intentionally left blank.



## List of Tables

Table 1-1: Display Port Pin Assignment .....	10
Table 1-2: GPIB Pin Description .....	11
Table 1-3: LED Indicator Legend .....	12
Table 1-4: USB 2.0 Port Pin Assignment.....	13
Table 1-5: PXIe-3935 Ethernet Port Pin Assignments.....	13
Table 1-6: D-Sub 9p COM Port Signal Functions .....	15
Table 1-7: Onboard Configuration Legend .....	16
Table B-1: BIOS Hot Key Functions.....	36
Table B-2: BIOS Main Setup Menu .....	37
Table B-3: BIOS Advanced Setup Menu.....	38
Table B-4: BIOS Boot Setup Menu .....	38
Table B-5: BIOS Security Setup Menu.....	39

This page intentionally left blank.

# 1 Introduction

The ADLINK PXIe-3935 PXI Express embedded controller, based on the Intel® Celeron® 2000E 2.2GHz processor, pairs superior performance with an unprecedented price point. Specifically conceived for hybrid PXI Express-based testing systems, the ADLINK PXIe-3935 delivers a rugged and stable platform for a wide variety of testing and measurement applications.

The PXIe-3935 provides ample interface flexibility, including two DisplayPort connectors, allowing connection to two monitors, dual USB 3.0 connections for high speed peripheral devices, dual Gigabit Ethernet ports with one for LAN connection and the other for controlling LXI instruments, four USB 2.0 ports for peripheral devices and USB instrument control, a Micro-D GPIB connector for GPIB instrument connection, and one RS-232/422/485 D-SUB9 connector for hybrid PXI-based testing systems control.

ADLINK's PXIe-3935 significantly reduces maintenance burdens with easily replaceable battery and upgradable storage and SODIMM modules. Backup BIOS also eases recovery in the event of a main BIOS crash.



NOTE:

Memory addressing over 4GB is OS-dependent, such that a 32-bit operating system may be unable to address memory space over 4GB. To fully utilize memory, 64-bit operating systems are required.

---

## 1.1 Features

- ▶ Ideal balance between performance and price point
- ▶ Intel® Celeron® 2000E 2.2GHz processor
- ▶ Dual channel DDR3L SODIMM up to 16GB 1600MHz
- ▶ 8 GB/s maximum system throughput
- ▶ Dual display port support
- ▶ 2.5" HDD or SSD support
- ▶ SATA 3Gb/s
- ▶ AHCI support
- ▶ Integrated I/O
  - ▷ Dual Gigabit Ethernet ports
  - ▷ Two USB3.0 Ports
  - ▷ Four USB 2.0 Ports
  - ▷ Built-in GPIB (IEEE488) controller
  - ▷ Dual DisplayPort connector
  - ▷ One COM port (D-sub9 serial)
  - ▷ Trigger I/O for advanced PXITM trigger functions
- ▶ Dual BIOS support for backup

## 1.2 Specifications

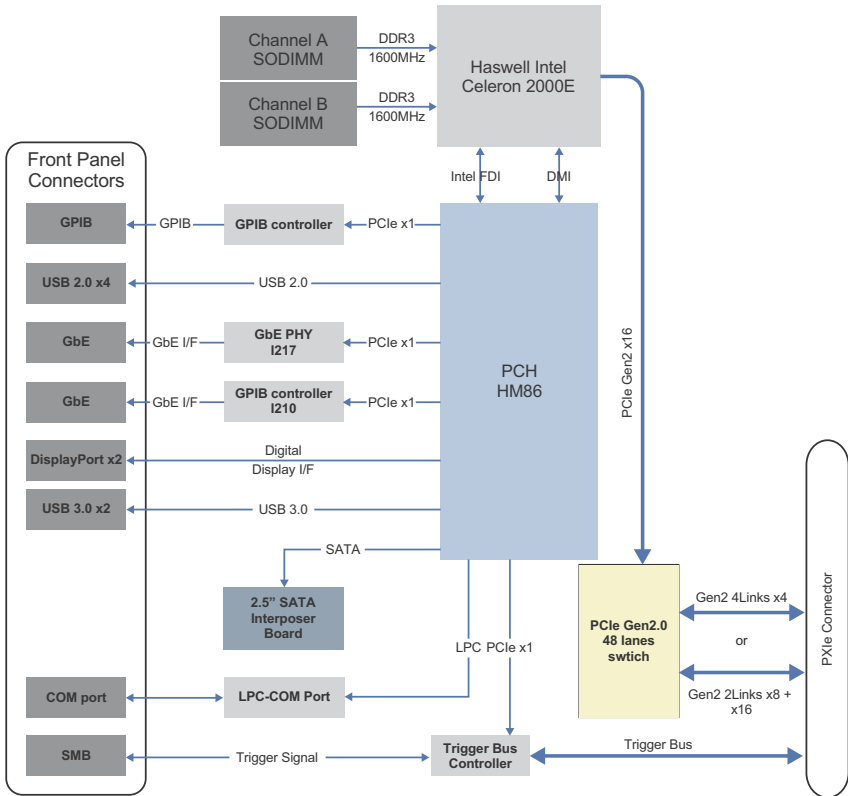

Figure 1-1: PXIe-3935 Functional Block Diagram

### Processor

- ▶ Intel® Celeron® 2000E 2.20GHz processor for maximum computing power
- ▶ DMI (Direct Media Interface) with 5 GT/s of bandwidth in each direction

## Chipset

Mobile Intel® HM86

## Memory

- ▶ 2x standard 204-pin DDR3L SODIMM sockets
- ▶ Support for 1333/1600MHz RAM up to 16 GB total
- ▶ Support for non-ECC unbuffered memory



NOTE:

The externally accessible SODIMM socket can accept replacement DDR3L DRAM DIMM modules. PXIe-3935 specifications and stability guarantees are only supported when ADLINK-provided DDR3L DRAM DIMM modules are used.

## Video

- ▶ DisplayPort supports up to 3840x 2160 @60Hz resolution
- ▶ DVI (with passive DisplayPort-to-DVI adapter) supports resolutions up to 1920 x 1200 @60Hz



NOTE:

DisplayPort adapters for other standards are supported, with maximum available resolution dependent on the adapter chosen

## Hard Drive

Built-in 2.5" 500GB SATA hard drive or 240GB SATA solid state hard drive.

## I/O Connectivity

Dual Gigabit Ethernet through two RJ-45 connectors with speed/link/active LED indicators on the front panel, with both supporting Wake on LAN.

## USB

Four USB 2.0 and two USB 3.0 ports on the front panel.

## COM port

One RS-232/422/485 D-SUB9 connector.

## GPIB

Onboard IEEE488 GPIB controller through Micro-D 25-pin connector on the front panel.

## Trigger I/O

One SMB connector on the front panel to route an external trigger signal to/from PXIe trigger bus

## Dimensions (3U PXI module)

3U/4-slot PXI standard.

80.94 W x 128.7 H x 212.9 D mm (3.15 x 5.01 x 8.3 in.)

## Weight

1.0kg (exclusive of packaging)

## Environmental

Operating temperature with SSD	0 to 55°C
Operating temperature with HDD	0 to 50°C
Storage temperature	-20 to 70°C
Relative humidity , non-condensing	5 to 95%

## Shock and Vibration

Functional shock 30 G, half-sine, 11 ms pulse duration

### Random vibration:

- ▶ Operating 5 to 500 Hz, 0.21 Grms, 3 axes
- ▶ Non-operating 5 to 500 Hz, 2.46 Grms, 3 axes



NOTE:

Environmental & Shock and Vibration values are only guaranteed with use of an ADLINK-provided SSD/HDD

### Certification

Electromagnetic compatibility:

- ▶ EMC/EMI: CE, FCC Class A
- ▶ CE Compliance EN 61326-1

The PXIe-3935 meets the essential requirements of applicable European Directives.

### Power Requirements

Voltage Rail	+3.3V	+5V	+12V	Total (W)
Maximum power consumption	3.3	38	1.2	42.5
Idle power consumption	3.3	22.5	1.2	27



### 1.3 Front Panel I/O & Indicators

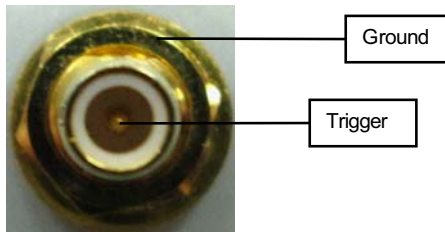

Figure 1-2: Front Panel

The PXIe-3935 provides the following I/O and indicators, as labeled on the front panel.

- ▶ PXI Trigger Connector (SMB jack)
- ▶ 2X DisplayPort Connectors
- ▶ GPIB Connector (Micro D-Sub 25P)
- ▶ Reset Button
- ▶ LED indicators
- ▶ 4X Type-A USB 2.0 connectors
- ▶ 2X Gigabit Ethernet
- ▶ 2X USB 3.0
- ▶ 1X COM port (D-sub9 serial)

### 1.3.1 PXIe Trigger Connector



**Figure 1-3: PXIe Trigger SMB Jack**

The PXIe trigger connector is a SMB jack, used to route external trigger signals to or from the PXIe backplane. Trigger signals are TTL-compatible and edge sensitive. The PXIe-3935 provides four

trigger routing modes from/to the PXIe trigger connector to synchronize PXIe modules, including

- ▶ From a selected trigger bus line to PXIe trigger connector
- ▶ From the PXIe trigger connector to a selected trigger bus line
- ▶ From software trigger to a selected trigger bus line
- ▶ From software trigger to PXIe trigger connector

All trigger modes are programmable by the provided driver. Please refer to Section A: PXIe Trigger I/O Function Reference for further information.

### 1.3.2 DisplayPort Connectors

Supporting monitor connection, with, if connecting to VGA/DVI/ HDMI monitors, installation of requisite adapters required. Dual display function is also supported

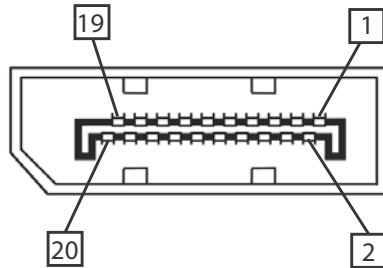

Pin	Signal	Pin	Signal
1	CN_DDPx0+	11	GND
2	GND	12	CN_DDPx3-
3	CN_DDPx0-	13	CN_DDPx_AUX_SEL
4	CN_DDPx1+	14	CN_DDPx_CONFIG2
5	GND	15	CN_DDPx_AUX+

Pin	Signal	Pin	Signal
6	CN_DDPx1-	16	GND
7	CN_DDPx2+	17	CN_DDPx_AUX-
8	GND	18	CN_DDPx_HPDP
9	CN_DDPx2-	19	GND
10	CN_DDPx3+	20	+V3.3_DDPx_PWR

**Table 1-1: Display Port Pin Assignment**

### 1.3.3 GPIB Connector

The GPIB connector on PXIe-3935 is a micro D-sub 25P connector, controlling external bench-top instruments. Connection to other instruments requires the ACL-IEEE488-MD1-A cable. The on-board GPIB controller provides:

- ▶ Full compatibility with IEEE 488 standard
- ▶ Up to 1.5MB/s data transfer rates
- ▶ Onboard 2 KB FIFO for read/write operations
- ▶ Driver APIs compatible with NI-488.2 driver software
- ▶ Connection with up to 14 instruments

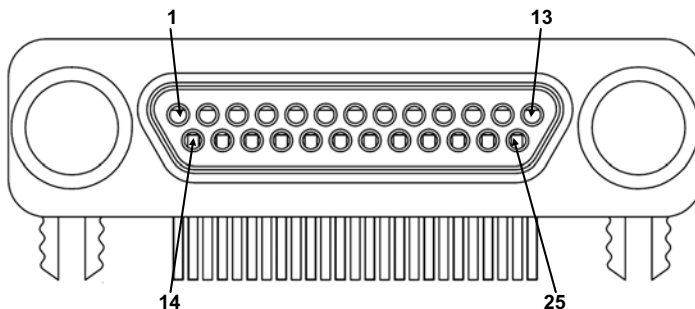

Pin	Signal	Description	Pin	Signal	Description
1	DIO1#	GPIB Data 1	14	DIO5#	GPIB Data 5
2	DIO2#	GPIB Data 2	15	DIO6#	GPIB Data 6

Pin	Signal	Description	Pin	Signal	Description
3	DIO3#	GPIB Data 3	16	DIO7#	GPIB Data 7
4	DIO4#	GPIB Data 4	17	DIO8#	GPIB Data 8
5	EOI	End Or Identify	18	REN	Remote Enable
6	DAV	Data Valid	19	Ground	Signal Ground
7	NRFD	Not Ready For Data	20	Ground	Signal Ground
8	NDAC	No Data Accepted	21	Ground	Signal Ground
9	IFC	Interface Clear	22	Ground	Signal Ground
10	SRQ	Service Request	23	Ground	Signal Ground
11	ATN	Attention	24	Ground	Signal Ground
12	Chassis Ground	Chassis Ground	25	Ground	Signal Ground
13	Ground	Signal Ground			

**Table 1-2: GPIB Pin Description**

### 1.3.4 Reset Button

The reset button, activated by insertion of any pin-like implement, executes a hard reset for the PXIe-3935.

### 1.3.5 LED Indicators

Four LED indicators on the front panel indicate operational status of the PXIe-3935, as follows.



**Figure 1-4: LED Indicators**

LED	Color	Description
PW	Green	Indicates system power, remaining lit when the system boots normally and main power supply is functioning
HD	Yellow	Indicates operating state of the HDD or SSD, flashing during access to or activity on the SATA HDD.
USR	Blue	User-programmable LED indicator

**Table 1-3: LED Indicator Legend**



NOTE:

In the event of malfunction, clear the CMOS (See “Clearing CMOS” on page 23.) and reboot the system. If the system fails to respond properly, please contact ADLINK for assistance.

### 1.3.6 USB 2.0 Ports

The PXIe-3935 provides four USB 2.0 ports via USB Type A connectors on the front panel, all compatible with hi-speed, full-speed and low-speed USB devices. Supported boot devices include USB flash drive, USB floppy, USB CD-ROM, and others, with boot priority and device settings configurable configured in BIOS. See “Boot Setup” on page 38. for more information.

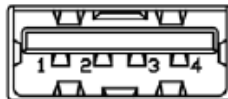
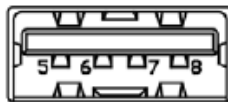

Pin	Signal
1/5	Power 5V

Pin	Signal
2/6	USB Data-
3/7	USB Data +
4/8	Ground

**Table 1-4: USB 2.0 Port Pin Assignment**



### 1.3.7 Gigabit Ethernet Ports

Dual Gigabit Ethernet connection is provided on the PXle-3935 front panel.

Pin	1000Base-T Signal	100/10Base-T Signal
1	MDI0+	TX+
2	MDI0-	TX-
3	MDI1+	RX+
4	MDI2+	Reserved
5	MDI2-	Reserved
6	MDI1-	RX-
7	MDI3+	Reserved
8	MDI3-	Reserved

**Table 1-5: PXle-3935 Ethernet Port Pin Assignments**

The Ethernet ports each include two LED indicators, one Active/Link indicator and one Speed indicator, functioning as follows.

	LED	Status	Description
	Active/Link (Yellow)	Off	Ethernet port is disconnected
		On	Ethernet port is connected with no data transmission
		Flashing	Ethernet port is connected with data transmitted/received
	Speed (Green/Orange)	Off	10 Mbps
		Green	100 Mbps
		Orange	1000 Mbps

### 1.3.8 COM Port

The COM port with D-sub 9P connectors supports RS-232/RS-422/RS-485 according to BIOS setting.

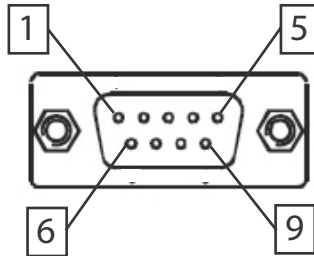

Figure 1-5: COM Port

Pin	Signal		
	RS-232	RS-422	RS-485
1	DCD#	TXD422-	485DATA-
2	RXD	TXD422+	485DATA+



Pin	Signal		
3	TXD	RXD422+	N/S
4	DTR#	RXD422-	N/S
5	GND	N/S	N/S
6	DSR#	N/S	N/S
7	RTS#	N/S	N/S
8	CTS#	N/S	N/S
9	RI#	N/S	N/S

**Table 1-6: D-Sub 9p COM Port Signal Functions**

### 1.3.9 USB 3.0 Ports

The PXIe-3935 provides two Type A USB 3.0 ports on the front panel, supporting SuperSpeed, Hi-Speed, full-speed, and low-speed transmission for downstream. Multiple boot devices, including USB flash, USB external HD, and USB CD-ROM drives are supported, with boot priority configured in BIOS.



NOTE:

While the USB 3.0 ports allow boot from CD-ROM, OS installation via CD-ROM is not supported

---

### 1.3.10 Onboard Connections and Settings

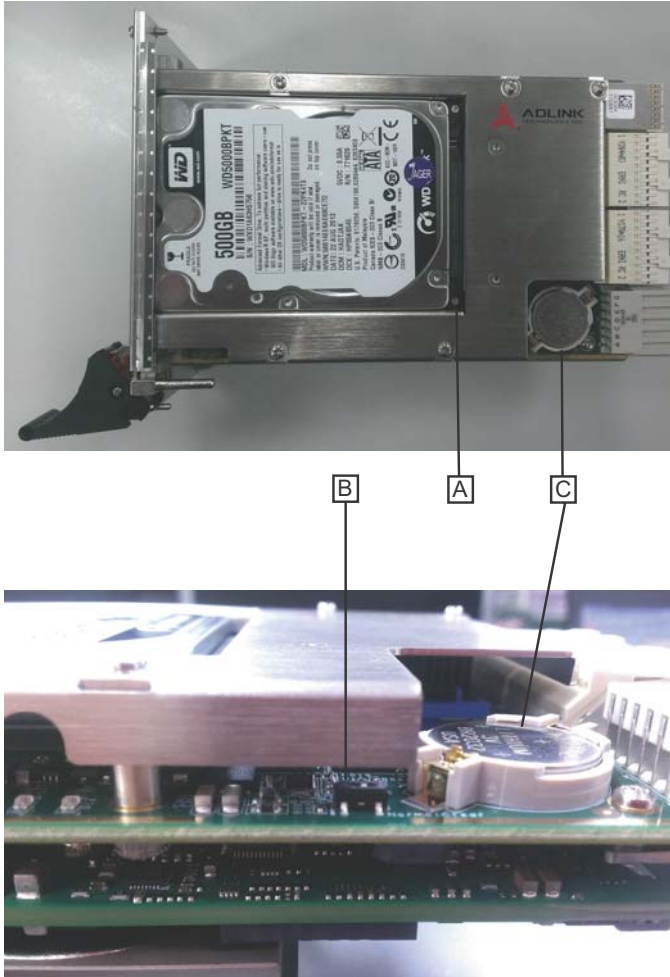

**Figure 1-6: PXle-3985 Onboard Configuration**

A	SATA Connector
B	Clear CMOS switch
C	System Battery

**Table 1-7: Onboard Configuration Legend**

## 2 Getting Started

This chapter describes procedures for installing the PXIe-3935 and making preparations for its operation, including hardware and software setup. Please note that the PXIe-3935 is shipped with RAM and HDD or SSD preinstalled. Please contact ADLINK or authorized dealer if there are any problems during the installation.



NOTE:

Diagrams and illustrated equipment are for reference only. Actual system configuration and specifications may vary.

---

### 2.1 Package Contents

Before beginning, check the package contents for any damage and ensure that the following items are included:

- ▶ PXIe-3985 Controller (equipped with RAM and HDD or SSD)
- ▶ DisplayPort-to-DVI adapter
- ▶ Quick Start Guide

If any of these items are missing or damaged, contact the dealer from whom you purchased the product. Save the shipping materials and carton in case you want to ship or store the product in the future.



WARNING:

Do not install or apply power to equipment that is damaged or missing components. Retain the shipping carton and packing materials for inspection. Please contact your ADLINK dealer/vendor immediately for assistance and obtain authorization before returning any product.

---

### 2.2 Operating System Installation

For more detailed information about the operating system, refer to the documentation provided by the operating system manufacturer. Preferred/supported operating systems for PXIe-3935 are:

- ▶ Windows 7 32/64-bit
- ▶ For other OS support, please contact ADLINK

Most operating systems require initial installation from a hard drive, floppy drive, or CD-ROM drive. The PXIe-3935 controller supports USB CD-ROM drive, USB flash disk, USB external hard drive, or a USB floppy drive as the first boot device. See “Boot Setup” on page 38. for information about setting the boot devices. These devices should be configured, installed, and tested with the supplied drivers before attempting to load the new operating system.



Read the release notes and installation documentation provided by the operating system vendor. Be sure to read all the README files or documents provided on the distribution disks, as these typically note documentation discrepancies or compatibility problems.

---

1. Select the appropriate boot device order from the BIOS Boot Setup Menu based on the OS installation media used. For example, if the OS is distributed on a bootable installation CD, select USB CD-ROM as the first boot device and reboot the system with the installation CD in the USB CD-ROM drive
2. Proceed with the OS installation as directed and be sure to select appropriate device types if prompted. Refer to the appropriate hardware manuals for specific device types and compatibility modes of ADLINK PXIe products.
3. When installation is complete, reboot the system and set the boot device order in the SETUP boot menu accordingly.

## 2.2.1 Driver Installation

Download requisite drivers, as follows, from <http://www.adlink-tech.com>.

1. Fully install Windows, which contains most standard I/O device drivers
2. Install the chipset driver
3. Install the graphic driver
4. Install the Ethernet driver
5. Install the GPIB driver
6. Install the management engine driver
7. Install the PXIe trigger driver
8. Install the USB 3.0 driver

## 2.2.2 Installation Environment

When preparing to install any equipment described in this manual, see “Chapter A: Important Safety Instructions.

Only install equipment in well lit areas on flat, sturdy surfaces with access to basic tools such as flat- and cross-head screwdrivers, preferably with magnetic heads as screws and standoffs are small and easily misplaced.

## Recommended Installation Tools

- ▶ Phillips (cross-head) screwdriver
- ▶ Flat-head screwdriver
- ▶ Anti-static wrist strap
- ▶ Anti-static mat

ADLINK PXIe-3935 system controllers are electrostatically sensitive and can be easily damaged by static electricity. The equipment must be handled on a grounded anti-static mat, and operators must wear an anti-static wristband, grounded at the same point as the anti-static mat.

Inspect the carton and packaging for damage. Shipping and handling may cause damage to the contents. Ensure that all contents are undamaged before installing.

---



CAUTION:

All equipment must be protected from static discharge and physical shock. Never remove any of the socketed parts except at a static-free workstation. Use the anti-static bag shipped with the product to handle the equipment and wear a grounded wrist strap when servicing or installing.

---

### 2.2.3 Installing the PXIe-3935

1. Locate the system controller slot (Slot 1)
2. Depress the red locking lever and release the latch
3. Align the controller's top and bottom edges with the card guides, and carefully slide the PXIe-3935 into the chassis, as shown



4. Elevate the latch until the PXIe-3935 is fully seated in the chassis backplane.
5. Fasten the four mounting screws on the front panel of PXIe-3935, and connect all peripheral devices.

## 2.2.4 Replacing the Hard Drive or Solid State Drive

The PXIe-3935 provides a SATA 2.0 port with a pre-installed 2.5" SATA hard drive or solid state drive. Replacing the HDD or SSD is accomplished as follows.

1. Locate the five screws attaching the drive to the bracket on the side of the PXIe-3935.
2. Remove the screws, as shown.



3. Gently lift and remove the SATA HDD or SSD
4. To install a HDD or SSD or other compatible SATA hard drive, reverse the steps and reinstall the PXIe-3935 into the PXIe system.



## 2.2.5 Replacing the Battery Backup

The PXIe-3935 is provided with a 3.0 V “coin cell” lithium battery, replacement of which is as follows.

1. Turn off the PXIe chassis.
2. Remove the PXIe-3935 embedded controller from the chassis. Observe all anti-static precautions.
3. To remove the battery, gently insert a small (approx. 5 mm) flathead screwdriver under the battery at the negative retaining clip. Gently pry up and the battery should easily pop out.
4. Place a fresh identical battery (CR2032 or equivalent) in the socket, ensuring that the positive pole (+) is facing upwards. The battery is most easily seated by first being inserted under the positive retaining clip, and then pushed downward at the negative retaining clip. The battery should easily snap into position.
5. Reinstall the embedded controller into the PXIe chassis and restore power.

## 2.2.6 Clearing CMOS

In the event of a system malfunction causing the PXIe-3935 to halt or fail to boot, clear the CMOS and restore the controller BIOS to its default settings. To clear the CMOS:

1. Shut down the controller operating system and turn off the PXIe Chassis.
2. Remove the PXIe-3935 from the chassis. Observe all anti-static precautions.
3. Locate the CMOS clear switch (SW1) on the board (See “Onboard Connections and Settings” on page 16.). Move the switch from Normal position



to Clear position



and wait for 5 seconds, then return the switch to Normal position.

4. Remount the controller into the PXIe chassis.
5. Press "Delete" or "ESC" to enter the BIOS setup when the splash logo appears.
6. Press "F3" to load Optimized defaults in BIOS setup
7. Modify the system date and time
8. Press "F4" to save configuration and exit

## 2.2.7 Initiating Backup BIOS Flash

BIOS flash on the PXIe-3935 is divided into Backup and Normal sections. In the event of a system malfunction causing the active PXIe-3935 BIOS to crash and then fail to boot, the system automatically switches to the secondary backup BIOS.



NOTE:

Please contact technical support to resolve halting or failure to boot issues caused by corrupted BIOS.

---

# Appendix A - PXIe Trigger I/O Function Reference

This appendix describes use of the PXIe trigger I/O function library for the PXIe-3935 controller, to program routing of trigger signals between the trigger I/O SMB connector on the front panel and the PXIe trigger bus on the backplane.

## A.1 Data Types

The PXIe-3935 library uses these data types in `pxitrigio.h` in the directory `X:\ADLINK\PXIe Trigger IO\Include`. It is recommended that you use these data types in your application programs. The table shows the data type names, ranges, and corresponding data types in C/C++, Visual Basic, and Delphi for reference.

Type	Description	Range	Type		
			C/C++ (for 32-bit compiler)	Visual Basic	Pascal (Delphi)
U8	8-bit ASCII character	0 to 255	unsigned char	Byte	Byte
I16	16-bit signed integer	-32768 to 32767	short	Integer	SmallInt
U16	16-bit unsigned integer	0 to 65535	unsigned short	Not supported by BASIC, use the signed integer (I16) instead	Word
I32	32-bit signed integer	-2147483648 to 2147483647	long	Long	LongInt
U32	32-bit unsigned integer	0 to 4294967295	unsigned long	Not supported by BASIC, use the signed long integer (I32) instead	Cardinal

Type	Description	Range	Type		
			C/C++ (for 32-bit compiler)	Visual Basic	Pascal (Delphi)
F32	32-bit single-precision floating-point	-3.402823E38 to 3.402823E38	float	Single	Single
F64	64-bit double-precision floating-point	1.7976831348 62315E308 to 1.7976831348 62315E309	double	Double	Double

## A.2 Function Library

This section provides detailed definitions of the functions available in the PXIe-3935 function library. Each function includes a description, list of supported cards, syntax, parameter list and Return Code information.

### A.2.1 TRIG\_Init

#### Description

Initializes trigger I/O function of PXIe-3935 controller. TRIG\_Init must be called before the invocation of any other trigger I/O function.

#### Supported Controllers

PXIe-3935, PXI-3980

#### Syntax

C/C++

```
I16 TRIG_Init()
```

Visual Basic

```
TRIG_Init As Integer
```

#### Parameter

*None*

**Return Code**

```

ERR_NoError
ERR_BoardBusy
ERR_OpenDriverFail
ERR_GetGPIOAddress

```

**A.2.2 TRIG\_Close****Description**

Closes trigger I/O function of PXIe-3935 controller, releasing resources allocated for the trigger I/O function. Users must invoke TRIG\_Close before exiting the application.

**Supported Controllers**

PXIe-3935, PXI-3980

**Syntax**

C/C++

```
I16 TRIG_Close()
```

Visual Basic

```
TRIG_Close() As Integer
```

**Parameter**

None

**Return Code**

```

ERR_NoError
ERR_BoardNoInit

```

**A.2.3 TRIG\_SetSoftTrg****Description**

Generates a TTL trigger signal to the trigger I/O SMB connector on the front panel or the PXIe trigger bus on the backplane by software command

**Supported Controllers**

PXIe-3935, PXI-3980

**Syntax**

C/C++

```
I16 TRIG_SetSoftTrg(U8 Status)
```

### Visual Basic

```
TRIG_SetSoftTrg (ByVal status As Byte) As  
Integer
```

### Parameters

#### *Status*

Logic level of trigger signal.

*Available value description:*

0: Logic low

1: Logic high

### Return Code

```
ERR_NoError  
ERR_BoardNoInit
```

## A.2.4 TRIG\_Trigger\_Route

### Description

Routes the trigger signal between the trigger I/O SMB connector on the front panel and the PXIe trigger bus on the backplane. This function also allows routing of the software-generated trigger signal to SMB connector or trigger bus.

### Supported Controllers

PXIe-3935, PXI-3980

### Syntax

#### C/C++

```
I16 TRIG_Trigger_Route (U32 source, U32 dest,  
U32 halfway)
```

### Visual Basic

```
TRIG_Trigger_Route (ByVal source As Long,  
ByVal dest As Long, ByVal halfway As Long) As  
Integer
```

### Parameters

*source*

Source of trigger routing. It can be one of the following values.

Available value	Description
PXI_TRIG_VAL_SMB	SMB connector on the front panel
PXI_TRIG_VAL_SOFT	Software-generated trigger signal
PXI_TRIG_VAL_TRIG0	PXIe trigger bus #0
PXI_TRIG_VAL_TRIG1	PXIe trigger bus #1
PXI_TRIG_VAL_TRIG2	PXIe trigger bus #2
PXI_TRIG_VAL_TRIG3	PXIe trigger bus #3
PXI_TRIG_VAL_TRIG4	PXIe trigger bus #4
PXI_TRIG_VAL_TRIG5	PXIe trigger bus #5
PXI_TRIG_VAL_TRIG6	PXIe trigger bus #6
PXI_TRIG_VAL_TRIG7	PXIe trigger bus #7

*dest*

Destination of trigger routing. It can be one of the following values.

Available value	Description
PXI_TRIG_VAL_SMB	SMB connector on the front panel
PXI_TRIG_VAL_TRIG0	PXIe trigger bus #0
PXI_TRIG_VAL_TRIG1	PXIe trigger bus #1
PXI_TRIG_VAL_TRIG2	PXIe trigger bus #2
PXI_TRIG_VAL_TRIG3	PXIe trigger bus #3
PXI_TRIG_VAL_TRIG4	PXIe trigger bus #4
PXI_TRIG_VAL_TRIG5	PXIe trigger bus #5
PXI_TRIG_VAL_TRIG6	PXIe trigger bus #6
PXI_TRIG_VAL_TRIG7	PXIe trigger bus #7

*halfway*

Halfway point of trigger routing. This parameter is used only to route the software-generated trigger signal to the SMB connector on the front panel. In this case, the halfway

should be set as one of the trigger bus lines, otherwise as PXI\_TRIG\_VAL\_NONE.

Available value	Description
PXI_TRIG_VAL_NONE	No halfway point
PXI_TRIG_VAL_TRIG0	PXle trigger bus #0
PXI_TRIG_VAL_TRIG1	PXle trigger bus #1
PXI_TRIG_VAL_TRIG2	PXle trigger bus #2
PXI_TRIG_VAL_TRIG3	PXle trigger bus #3
PXI_TRIG_VAL_TRIG4	PXle trigger bus #4
PXI_TRIG_VAL_TRIG5	PXle trigger bus #5
PXI_TRIG_VAL_TRIG6	PXle trigger bus #6
PXI_TRIG_VAL_TRIG7	PXle trigger bus #7

### Return Code

ERR\_NoError  
 ERR\_BoardNoInit  
 ERR\_Set\_Path

## A.2.5 TRIG\_Trigger\_Clear

### Description

Clears the trigger routing setting

### Supported Controllers

PXle-3935, PXI-3980

### Syntax

C/C++

```
I16 TRIG_Trigger_Clear()
```

Visual Basic

```
TRIG_Trigger_Clear() As Integer
```

### Parameters

None

### Return Code

ERR\_NoError  
 ERR\_BoardNoInit



ERR\_Trigger\_Clr

## A.2.6 TRIG\_GetSoftTrg

### Description

Acquires the current software trigger state, with default state after system boot of Logic Low

### Supported Controllers

PXIe-3935, PXI-3980

### Syntax

C/C++

```
I16 TRIG_GetSoftTrg(U8 *Status)
```

Visual Basic

```
TRIG_GetSoftTrg (status As Byte) As Integer
```

### Parameters

*Status*

Returns the logic level of software trigger signal

Returned value:

0: Logic low

1: Logic high

### Return Code

ERR\_NoError

ERR\_BoardNoInit

ERR\_Query\_Status

## A.2.7 TRIG\_Trigger\_Route\_Query

### Description

Acquires the current trigger signal routing path

### Supported Controllers

PXIe-3935, PXI-3980

### Syntax

C/C++

I16 TRIG\_Trigger\_Route\_Query (U32\* source, U32\* dest, U32\* halfway)

### Visual Basic

TRIG\_Trigger\_Route\_Query (source As Long, dest As Long, halfway As Long) As Integer

### Parameters

#### *source*

Returns to the current source of trigger routing, with possible values including:

Available Definition	Defined Value
PXI_TRIG_VAL_NONE	0
PXI_TRIG_VAL_SMB	2
PXI_TRIG_VAL_SOFT	3
PXI_TRIG_VAL_TRIG0	111
PXI_TRIG_VAL_TRIG1	112
PXI_TRIG_VAL_TRIG2	113
PXI_TRIG_VAL_TRIG3	114
PXI_TRIG_VAL_TRIG4	115
PXI_TRIG_VAL_TRIG5	116
PXI_TRIG_VAL_TRIG6	117
PXI_TRIG_VAL_TRIG7	118

#### *dest*

Returns to the current destination of trigger routing, with possible values including:

Available Definition	Defined Value
PXI_TRIG_VAL_NONE	0
PXI_TRIG_VAL_SMB	2
PXI_TRIG_VAL_TRIG0	111
PXI_TRIG_VAL_TRIG1	112
PXI_TRIG_VAL_TRIG2	113
PXI_TRIG_VAL_TRIG3	114
PXI_TRIG_VAL_TRIG4	115

Available Definition	Defined Value
PXI_TRIG_VAL_TRIG5	116
PXI_TRIG_VAL_TRIG6	117
PXI_TRIG_VAL_TRIG7	118

*halfway*

Returns to the current halfway point of trigger routing, with possible values including:

Available Value	Description
PXI_TRIG_VAL_NONE	0
PXI_TRIG_VAL_TRIG0	111
PXI_TRIG_VAL_TRIG1	112
PXI_TRIG_VAL_TRIG2	113
PXI_TRIG_VAL_TRIG3	114
PXI_TRIG_VAL_TRIG4	115
PXI_TRIG_VAL_TRIG5	116
PXI_TRIG_VAL_TRIG6	117
PXI_TRIG_VAL_TRIG7	118

### Return Code

ERR\_NoError  
 ERR\_BoardNoInit  
 ERR\_Query\_Status

## A.2.8 TRIG\_GetDriverRevision

### Description

Acquires the PXIe Trigger software driver version; format of the version number is major.minor1.minor2

### Supported Controllers

PXIe-3935, PXI-3980

### Syntax

C/C++

```
I16 TRIG_GetDriverRevision(unsigned short
*major, unsigned short *minor1, unsigned short
*minor2)
```

## Visual Basic

```
TRIG_GetDriverRevision (major As Integer,
minor1 As Integer, minor2 As Integer) As Integer
```

## Parameters

*major*

Returns the major version number of the PXIe trigger software driver

*minor1*

Returns the first minor version number of the PXIe trigger software driver

*minor2*

Returns the second minor version number of the PXIe trigger software driver

## Return Code

ERR\_NoError

ERR\_Query\_Revision

## Appendix B BIOS Setup

The Basic Input/Output System (BIOS) provides a basic level of communication between the processor and peripherals. In addition, the BIOS also contains code for various advanced features applied to the PXIe-3935 controller. The BIOS setup program includes menus for configuring settings and enabling PXIe-3935 controller features.



Changing BIOS settings may result in incorrect operation and possibly an inability to boot. If this occurs, follow the instructions in Section 2.2.6: Clearing CMOS to clear CMOS and restore default settings. In general, do not change a BIOS setting unless you are absolutely certain of the consequences.

### B.1 Starting the BIOS

1. Power on or reboot the PXIe-3935 controller.
2. Press the <Delete> key when the controller beeps. This should be concurrent with the main startup screen. The BIOS setup program loads after a short delay.
3. The Main menu is displayed when you first enter the BIOS setup program.



In most cases, the < Delete > key is used to invoke the setup screen. There are several cases that use other keys, such as < F1 >, < F2 >, and so on.

The main BIOS setup menu is the first screen that you can navigate. Each main BIOS setup menu option is described in this user's guide.

The Main BIOS setup menu screen has two main frames. The left frame displays all the options that can be configured. "Grayed" options cannot be configured, "Blue" options can be.

The right frame displays the key legend. Above the key legend is an area reserved for a text message. When an option is selected in the left frame, it is highlighted in white. Often a text message will accompany it.

## Navigation

The BIOS setup/utility uses a key-based navigation system called hot keys. Most BIOS setup utility hot keys can be used at any time during setup navigation, as follows.

Key(s)	Function
Right Arrow, Left Arrow	Moves between different setup menus
Up Arrow, Down Arrow	Moves between options within a setup menu
<Enter>	Opens a submenu or displays all available settings for a highlighted configuration option
<Esc>	Returns to the previous menu and shortcuts to the Exit menu from top-level menus
<+> and <->	Cycles between all available settings
<Tab>	Selects time and date fields
<F1>	Opens the general help window for the BIOS
<F2>	Loads previous values into the BIOS
<F3>	Loads the optimal default BIOS settings
<F4>	Saves the current configuration and exits BIOS setup

**Table B-1: BIOS Hot Key Functions**



NOTE:

A hot key legend is located in the right frame on most setup screens.

The < F8 > key on your keyboard is the Fail-Safe key. It is not displayed on the key legend by default. To set the Fail-Safe settings of the BIOS, press the < F8 > key on your keyboard. It is located on the upper row of a standard 101 keyboard. The Fail-Safe settings allow the motherboard to boot up with the least amount of options set. This can lessen the probability of conflicting settings.

## B.2 Main Setup

When you first enter the Setup Utility, you will enter the Main setup screen. You can always return to the Main setup screen by selecting the Main tab.

The Main Setup menu provides basic controller information and allows the system time and date to be set, as follows.

Item	
BIOS Information	Includes BIOS version and date
System Information	Lists processor and PCH information
System Management	Includes board information and system health data
System Date & Time	
System Date	Sets system date, entered in MM/DD/YY format
System Time	Sets system time, entered in HH:MM:SS format.
Access Level	Displays current access level, default is Administrator

**Table B-2: BIOS Main Setup Menu**

## B.3 Advanced Setup

Select the Advanced tab from the setup screen to enter the Advanced BIOS Setup screen. You can select any of the items in the left frame of the screen, such as SuperIO Configuration, to go to the submenu for that item. Display an Advanced BIOS Setup option by highlighting it using the < Arrow > keys. The Advanced BIOS Setup options are as follows.

Item	
CPU Configuration	Displays processor type, speed, system bus speed, and other information
Memory Configuration	Displays memory information
Graphics Configuration	Configures graphics

Item	
USB Configuration	Provides USB support and lists devices in USB ports
Hardware Health Configuration	Displays system voltages and temperatures
Onboard Device Configuration	Enables/disables LAN and SATA ports
Advanced Power Management	Shows Watch Dog Timer status

**Table B-3: BIOS Advanced Setup Menu**

## B.4 Boot Setup

Item	
<b>Boot Configuration</b>	
Setup Prompt Timeout	Sets time window in which Setup key can be selected, in seconds
Boot Numlock State	Sets keyboard Numlock status
Quiet Boot	When disabled, allows POST messages to be viewed, with default Enabled
Fast Boot	Sets boot with initialization of minimal devices required to launch active boot option
<b>Boot Option Priorities</b>	
1st Boot	Selects primary boot source, with default SATA HDD
2nd Boot	Selects secondary boot source
Hard Drive BBS Priorities	Sets order of legacy devices in this group

**Table B-4: BIOS Boot Setup Menu**

## B.5 Security Setup

The system can be configured to require all users to enter a password (either Administrator or User) every time the system boots or when Setup is executed. Administrators and User passwords activate different levels of security.



If passwords are used, the system prompts for a three- to twenty-character password. Typed passwords are not displayed.

Item	
Password Description	
Administrator Password	Sets administrative level password for BIOS
User Password	Sets user level passwords for BIOS

**Table B-5: BIOS Security Setup Menu**



Passwords are not recoverable. Please ensure that all passwords are recorded elsewhere. If your passwords are lost, NVRAM must be erased and reconfigured.

## B.6 Save & Exit Setup

The following options for saving and exiting can be chosen in this menu.

### Save Changes and Exit

- ▶ Save Changes and Reset
- ▶ Discard Changes and Reset

### Save Option

- ▶ Save Changes
- ▶ Discard Changes
- ▶ Restore Defaults
- ▶ Save as User Defaults
- ▶ Restore User Defaults



NOTE:

The "Restore the default values for all setup options" selection does not restore the original boot priority sequence. You must use the Boot Setup Menu (see "Boot Setup" on page 38) to manually restore the boot priority sequence.

---

## Important Safety Instructions

For user safety, please read and follow all instructions, Warnings, Cautions, and Notes marked in this manual and on the associated device before handling/operating the device, to avoid injury or damage.

*S'il vous plaît prêter attention stricte à tous les avertissements et mises en garde figurant sur l'appareil , pour éviter des blessures ou des dommages.*

- ▶ Read these safety instructions carefully
- ▶ Keep the User's Manual for future reference
- ▶ Read the Specifications section of this manual for detailed information on the recommended operating environment
- ▶ The device can be operated at an ambient temperature of 50°C
- ▶ When installing/mounting or uninstalling/removing device; or when removal of a chassis cover is required for user servicing (See "Getting Started" on page 17.):
  - ▷ Turn off power and unplug any power cords/cables
  - ▷ Reinstall all chassis covers before restoring power
- ▶ To avoid electrical shock and/or damage to device:
  - ▷ Keep device away from water or liquid sources
  - ▷ Keep device away from high heat or humidity
  - ▷ Keep device properly ventilated (do not block or cover ventilation openings)
  - ▷ Always use recommended voltage and power source settings
  - ▷ Always install and operate device near an easily accessible electrical outlet
  - ▷ Secure the power cord (do not place any object on/over the power cord)
  - ▷ Only install/attach and operate device on stable surfaces and/or recommended mountings
- ▶ If the device will not be used for long periods of time, turn off and unplug from its power source

- ▶ Never attempt to repair the device, which should only be serviced by qualified technical personnel using suitable tools
- ▶ A Lithium-type battery may be provided for uninterrupted backup or emergency power.



Risk of explosion if battery is replaced with one of an incorrect type; please dispose of used batteries appropriately.  
*Risque d'explosion si la pile est remplacée par une autre de type incorrect. Veuillez jeter les piles usagées de façon appropriée.*

---

- ▶ The device must be serviced by authorized technicians when:
  - ▷ The power cord or plug is damaged
  - ▷ Liquid has entered the device interior
  - ▷ The device has been exposed to high humidity and/or moisture
  - ▷ The device is not functioning or does not function according to the User's Manual
  - ▷ The device has been dropped and/or damaged and/or shows obvious signs of breakage
- ▶ Disconnect the power supply cord before loosening the thumbscrews and always fasten the thumbscrews with a screwdriver before starting the system up
- ▶ It is recommended that the device be installed only in a server room or computer room where access is:
  - ▷ Restricted to qualified service personnel or users familiar with restrictions applied to the location, reasons therefor, and any precautions required
  - ▷ Only afforded by the use of a tool or lock and key, or other means of security, and controlled by the authority responsible for the location

	<p><b>BURN HAZARD</b></p> <p>Touching this surface could result in bodily injury. To reduce risk, allow the surface to cool before touching.</p> <p><b>RISQUE DE BRÛLURES</b></p> <p><i>Ne touchez pas cette surface, cela pourrait entraîner des blessures.</i></p> <p><i>Pour éviter tout danger, laissez la surface refroidir avant de la toucher.</i></p>
---	---

This page intentionally left blank.

# Getting Service

**Ask an Expert:** <http://askanexpert.adlinktech.com>

## **ADLINK Technology, Inc.**

**Address:** 9F, No.166 Jian Yi Road, Zhonghe District  
New Taipei City 235, Taiwan  
新北市中和區建一路 166 號 9 樓  
**Tel:** +886-2-8226-5877  
**Fax:** +886-2-8226-5717  
**Email:** [service@adlinktech.com](mailto:service@adlinktech.com)

## **Ampro ADLINK Technology, Inc.**

**Address:** 5215 Hellyer Avenue, #110  
San Jose, CA 95138, USA  
**Tel:** +1-408-360-0200  
**Toll Free:** +1-800-966-5200 (USA only)  
**Fax:** +1-408-360-0222  
**Email:** [info@adlinktech.com](mailto:info@adlinktech.com)

## **ADLINK Technology (China) Co., Ltd.**

**Address:** 上海市浦东新区张江高科技园区芳春路 300 号 (201203)  
300 Fang Chun Rd., Zhangjiang Hi-Tech Park  
Pudong New Area, Shanghai, 201203 China  
**Tel:** +86-21-5132-8988  
**Fax:** +86-21-5132-3588  
**Email:** [market@adlinktech.com](mailto:market@adlinktech.com)

## **ADLINK Technology Beijing**

**Address:** 北京市海淀区上地东路 1 号盈创动力大厦 E 座 801 室(100085)  
Rm. 801, Power Creative E, No. 1 Shang Di East Rd.  
Beijing, 100085 China  
**Tel:** +86-10-5885-8666  
**Fax:** +86-10-5885-8626  
**Email:** [market@adlinktech.com](mailto:market@adlinktech.com)

## **ADLINK Technology Shenzhen**

**Address:** 深圳市南山区科技园南区高新南七道 数字技术园  
A1 栋 2 楼 C 区 (518057)  
2F, C Block, Bldg. A1, Cyber-Tech Zone, Gao Xin Ave. Sec. 7  
High-Tech Industrial Park S., Shenzhen, 518054 China  
**Tel:** +86-755-2643-4858  
**Fax:** +86-755-2664-6353  
**Email:** [market@adlinktech.com](mailto:market@adlinktech.com)

## **LiPPERT ADLINK Technology GmbH**

**Address:** Hans-Thoma-Strasse 11  
D-68163 Mannheim, Germany  
**Tel:** +49-621-43214-0  
**Fax:** +49-621 43214-30  
**Email:** [emea@adlinktech.com](mailto:emea@adlinktech.com)

## **PENTA ADLINK Technology GmbH**

Ulrichsbergerstrasse 17  
94469 Deggendorf, Germany  
**Tel:** +49 (0) 991 290 94 – 10  
**Fax:** +49 (0) 991 290 94 - 29  
**Email:** [emea@adlinktech.com](mailto:emea@adlinktech.com)

**ADLINK Technology, Inc. (French Liaison Office)**

Address: 6 allée de Londres, Immeuble Ceylan  
91940 Les Ulis, France  
Tel: +33 (0) 1 60 12 35 66  
Fax: +33 (0) 1 60 12 35 66  
Email: france@adlinktech.com

**ADLINK Technology Japan Corporation**

Address: 〒101-0045 東京都千代田区神田鍛冶町 3-7-4  
神田 374 ビル 4F  
KANDA374 Bldg. 4F, 3-7-4 Kanda Kajicho,  
Chiyoda-ku, Tokyo 101-0045, Japan  
Tel: +81-3-4455-3722  
Fax: +81-3-5209-6013  
Email: japan@adlinktech.com

**ADLINK Technology, Inc. (Korean Liaison Office)**

Address: 경기도 성남시 분당구 수내로 46 번길 4 경동빌딩 2 층  
(수내동 4-4 번지) (우) 463-825  
2F, Kyungdong B/D, 4 Sunae-ro 46 beon-gil  
Bundang-gu, Seongnam-si, Gyeonggi-do, Korea, 463-825  
Toll Free +82-800-800-0585  
Tel +82-31-786-0585  
Fax +82-31-786-0583  
Email: korea@adlinktech.com

**ADLINK Technology Singapore Pte. Ltd.**

Address: 84 Genting Lane #07-02A, Cityneon Design Centre  
Singapore 349584  
Tel: +65-6844-2261  
Fax: +65-6844-2263  
Email: singapore@adlinktech.com

**ADLINK Technology Singapore Pte. Ltd. (Indian Liaison Office)**

Address: #50-56, First Floor, Spearhead Towers  
Margosa Main Road (between 16th/17th Cross)  
Malleswaram, Bangalore - 560 055, India  
Tel: +91-80-65605817, +91-80-42246107  
Fax: +91-80-23464606  
Email: india@adlinktech.com

**ADLINK Technology, Inc. (Israeli Liaison Office)**

Address: 27 Maskit St., Corex Building  
PO Box 12777  
Herzliya 4673300, Israel  
Tel: +972-54-632-5251  
Fax: +972-77-208-0230  
Email: israel@adlinktech.com

**ADLINK Technology, Inc. (UK Liaison Office)**

Tel: +44 774 010 59 65  
Email: UK@adlinktech.com