



**ADLINK**  
TECHNOLOGY INC.

# PXES-2590

3U 9-Slot PXI Express Chassis

## User's Manual



**Manual Rev.:** 2.00  
**Revision Date:** June 29, 2012  
**Part No:** 50-17038-1000



Recycled Paper

**Advance Technologies; Automate the World.**

# Revision History

Revision	Release Date	Description of Change(s)
2.00	2012/6/29	Initial Release

# Preface

## **Copyright 2012 ADLINK TECHNOLOGY, INC.**

This document contains proprietary information protected by copyright. All rights are reserved. No part of this manual may be reproduced by any mechanical, electronic, or other means in any form without prior written permission of the manufacturer.

## **Disclaimer**

The information in this document is subject to change without prior notice in order to improve reliability, design, and function and does not represent a commitment on the part of the manufacturer.

In no event will the manufacturer be liable for direct, indirect, special, incidental, or consequential damages arising out of the use or inability to use the product or documentation, even if advised of the possibility of such damages.

## **Environmental Responsibility**

ADLINK is committed to fulfill its social responsibility to global environmental preservation through compliance with the European Union's Restriction of Hazardous Substances (RoHS) directive and Waste Electrical and Electronic Equipment (WEEE) directive. Environmental protection is a top priority for ADLINK. We have enforced measures to ensure that our products, manufacturing processes, components, and raw materials have as little impact on the environment as possible. When products are at their end of life, our customers are encouraged to dispose of them in accordance with the product disposal and/or recovery programs prescribed by their nation or company.

## **Trademarks**

Product names mentioned herein are used for identification purposes only and may be trademarks and/or registered trademarks of their respective companies.

## Conventions

Take note of the following conventions used throughout this manual to make sure that users perform certain tasks and instructions properly.



NOTE:

Additional information, aids, and tips that help users perform tasks.

---



CAUTION:

Information to prevent **minor** physical injury, component damage, data loss, and/or program corruption when trying to complete a task.

---



WARNING:

Information to prevent **serious** physical injury, component damage, data loss, and/or program corruption when trying to complete a specific task.

---

# Table of Contents

<b>Revision History</b> .....	<b>ii</b>
<b>Preface</b> .....	<b>iii</b>
<b>List of Figures</b> .....	<b>vii</b>
<b>List of Tables</b> .....	<b>ix</b>
<b>1 Introduction</b> .....	<b>1</b>
1.1 Features.....	2
1.2 Specifications.....	3
1.3 Schematics .....	6
1.4 Connectors, I/O, and Controls .....	9
1.4.1 Front Panel.....	9
1.4.2 Rear Panel.....	10
1.4.3 Backplane.....	12
<b>2 Getting Started</b> .....	<b>19</b>
2.1 Package Contents .....	19
2.2 Cooling Considerations.....	20
2.3 Hardware Installation .....	21
2.3.1 Installing the System Controller.....	21
2.3.2 Installing Peripheral Modules .....	23
2.3.3 Powering Up the System .....	26
<b>3 System Management</b> .....	<b>27</b>
3.1 Installing the Monitor Utility.....	27
3.2 Monitoring the PXES-2590 .....	27
3.2.1 Connect Control.....	28
3.2.2 Threshold and Control.....	30
3.2.3 Chassis Status.....	32

<b>4</b>	<b>Monitoring/Control Functions</b>	<b>33</b>
4.1	SMBus API	33
4.2	Function Overview	33
4.3	Function Library	34
<b>A</b>	<b>Appendix: PMK-1524 Monitor Kit</b>	<b>57</b>
A.1	Overview	57
A.2	Specifications	58
A.3	Package Contents	59
A.4	Installing the PMK-1524	60
A.5	Connecting the PMK-1524	65
A.5.1	Keyboard Detachment	66
A.6	Driver Installation	66
A.7	OSD Controls and Menu	71
A.7.1	OSD Menus	72
<b>B</b>	<b>Appendix: Troubleshooting and Maintenance</b>	<b>73</b>
B.1	Installation Problems	73
B.2	Basic Troubleshooting	74
B.3	Maintenance	75
B.3.1	Handling the Chassis	75
B.3.2	Cleaning the Exterior	75
B.3.3	Power Requirements	75
	<b>Important Safety Instructions</b>	<b>77</b>
	<b>Getting Service</b>	<b>79</b>

## List of Figures

Figure 1-1:	Front View .....	6
Figure 1-2:	Right Side View .....	6
Figure 1-3:	Left Side View.....	7
Figure 1-4:	Top View.....	7
Figure 1-5:	Underside View .....	8
Figure 1-6:	PXES-2590 Front Panel .....	9
Figure 1-7:	PXES-2590 Rear Panel.....	10
Figure 1-8:	Inhibit/ Voltage Monitoring Connector .....	12
Figure 1-9:	PXES-2590 Backplane .....	12
Figure 1-10:	Single-ended Star Trigger Routing .....	13
Figure 1-11:	Differential Star Trigger Routing .....	14
Figure 1-12:	3U hybrid slot compatible PXI-1 peripheral module .	15
Figure 1-13:	3U PXI Express peripheral module .....	15
Figure 1-14:	PXES-2590 Backplane Indicators .....	17
Figure 3-1:	FTP Monitor Interface.....	28
Figure 3-2:	Target Temperature Parameters and Legend .....	31
Figure A-1:	PMK-1524.....	57
Figure A-2:	PXES-2590 Chassis Schematic .....	60
Figure A-3:	PMK-1524 Connection to PXES-2590.....	65
Figure A-4:	PMK-1524 Keyboard Detachment.....	66
Figure A-5:	Driver Installation Introduction .....	66
Figure A-6:	Installation Start.....	67
Figure A-7:	Interface Selection 1 .....	68
Figure A-8:	Interface Selection 1 .....	69
Figure A-9:	4-point Calibration Setup .....	70
Figure A-10:	OSD Controls .....	71

This page intentionally left blank.



## List of Tables

Table 1-1: Front Panel Legend .....	9
Table 1-2: Front Panel Indicators.....	10
Table 1-3: Rear Panel Legend.....	11
Table 1-4: Backplane Indicator Legend .....	17
Table 1-5: 10MHz Reference Clock Priority.....	18
Table 3-1: Log Options Commands.....	29
Table 4-1: PXES-2590 Functions .....	34
Table A-1: PMK-1524 Legend.....	58
Table A-2: PXES-2590 Chassis Schematic Legend .....	60

This page intentionally left blank.

# 1 Introduction

The ADLINK PXES-2590 is a 9-slot PXI Express chassis with advanced features and functions. Compliant with PXI Express and cPCI Express specifications, the PXES-2590 offers one system slot, one system timing slot, and seven hybrid peripheral slots for versatile testing and measurement applications requiring enhanced bandwidth. The hybrid-slot design accepts installation of CompactPCI, PXI, CompactPCI Express, and PXI Express modules into any peripheral slot, maximizing flexibility. The PXES-2590 is built on a four-link PXI express chassis with up to 8 GB/s system bandwidth, and 1 GB/s slot bandwidth for all peripheral slots.

The PXES-2590 implements a smart system monitoring controller, reporting full chassis status, including fan speed, system voltages, and internal temperature.

Equipped with an industrial grade AC power supply, the PXES-2590 can provide 400 W in environments from 0°C to 55°C, and features an innovative cooling scheme providing superior heat dissipation. Two 185.9CFM fans in the rear section of the chassis draw cool air from apertures on the bottom and front of the chassis, over the PXI modules, and exhausted to the rear. This innovative cooling design provides, not only exceptional efficiency of heat dissipation, but also superior uniformity for each PXI slot. BNC connectors for 10 MHz clock input/output on the rear panel increase chassis flexibility, enabling synchronization with supplementary devices.

## 1.1 Features

- ▶ PXI™-5 PXI Express hardware specification Rev.1.0 compliant
- ▶ 9-slot PXI Express chassis with one system slot, one system timing slot, and seven hybrid peripheral slots
- ▶ Four-link PXI Express chassis
- ▶ Up to 8 GB/s system bandwidth
- ▶ Up to 1 GB/s peripheral bandwidth for all slots
- ▶ 0°C to 55°C extended operating temperature range
- ▶ Intelligent chassis management
  - ▷ Automatic fan speed control
  - ▷ Chassis status monitoring and reporting
  - ▷ Remote chassis power on/off control
- ▶ BNC connectors for 10 MHz clock input/output
- ▶ 400 W industrial-grade AC power supply
- ▶ Power, temperature, and fan monitoring LEDs

## 1.2 Specifications

The PXES-2590 complies with the PXI™-5 Specification Rev.1.0 and accepts all modules compliant with the PXI™-5 and Compact PCI specification.

<b>General Specifications</b>			
<b>Power Supply</b>			
AC Input (*guaranteed by power supply design)			
Input voltage range		100 to 240 VAC	
Operating voltage range*		85 to 264 VAC	
Input voltage frequency		50 to 60 Hz	
Operating voltage frequency*		47 to 63 Hz	
Input current rating			
115 VAC		13 A	
230 VAC		10 A	
DC Output			
Maximum total usable power		400 W	
VDC	Maximum	Load Regulation	Maximum Ripple & Noise
+5V	23.0 A	±3%	50 mV
+12V system slot	15.0 A	±3%	50 mV
+12V peripheral slots	16.0 A	±3%	50 mV
+3.3V	33.0 A	±3%	50 mV
-12V	1.75 A	±3%	50 mV
<b>10 MHz System Reference Clock (10 MHz REF)</b>			
Maximum clock skew between slots		300 ps	
Built-in 10 MHz clock Accuracy		±50 ppm	
BNC Output amplitude		1 Vpk-pk ±20% square-wave into 50 Ω 2 Vpk-pk unloaded	
BNC Output impedance		50 Ω ±5 Ω	
<b>External 10 MHz clock source input requirements</b>			
Frequency input		10 MHz ±100 PPM	

<b>General Specifications</b>	
Input signal (10MHz REF In BNC)	100 mVPP to 5 VPP(square or sine)
Input impedance (10MHz REF In BNC)	50 $\Omega$ $\pm$ 5 $\Omega$
Input signal (PXI_CLK10_IN on fifth slot)	5 V or 3.3 V TTL signal
<b>100 MHz System Reference Clock: PXIe_CLK100</b>	
Maximum slot-to-slot skew	100 ps
Accuracy	$\pm$ 25 ppm
<b>Cooling</b>	
Fans	2 sets of 185.9 CFM fans
Per-slot cooling capacity	30 W (verified by 55°C chamber test)
<b>Physical</b>	
Slots	9 (1 x system slot, 1 x system timing slot, 7 x hybrid peripheral slots)
Dimensions	321.9 (W) x 191.4 (H) x 465.3 (D) mm (12.7 x 7.5 x 18 in.)
Weight	8.8 kg (19.4 lb)
<b>Environmental</b>	
Storage	Ambient temperature: -20 to 70°C Relative humidity: 10 to 90%, noncondensing
Operating	Ambient temperature: 0 to 55°C Relative humidity: 10 to 90%, noncondensing
Functional shock	30 G, half-sine, 11 ms pulse duration
Random Vibration	Operating: 5 to 500 Hz, 0.31 Grms, 3 axes Nonoperating: 5 to 500 Hz, 2.46 Grms, 3 axes
<b>Certification</b>	
Safety	EN 61010-1
Electromagnetic Compatibility	Emissions: EN 55011 Class A Immunity: EN 61326-1

**General Specifications**

CE Compliance

Meets essential requirements of applicable European Directives, as amended for CE Marking:  
Low-Voltage Directive (safety): 73/23/EEC  
Electromagnetic Compatibility Directive (EMC): 9/336/EEC

### 1.3 Schematics



Please note that all dimensions are shown in mm (millimeters)

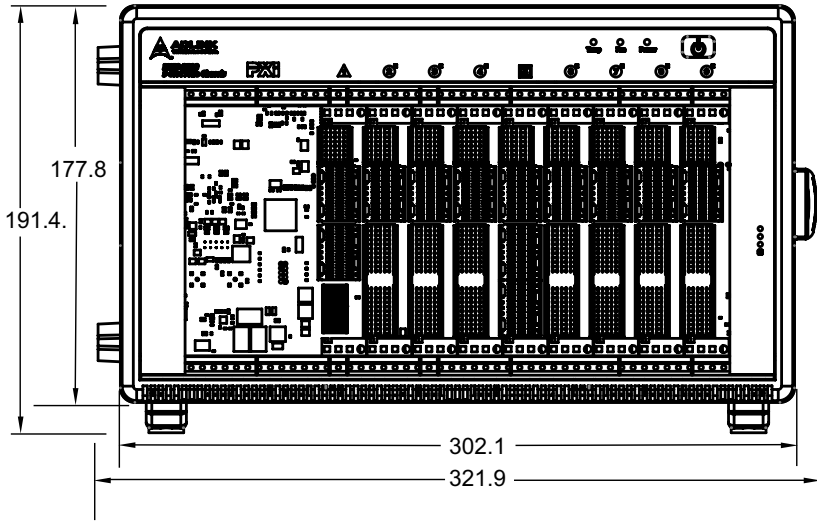


Figure 1-1: Front View

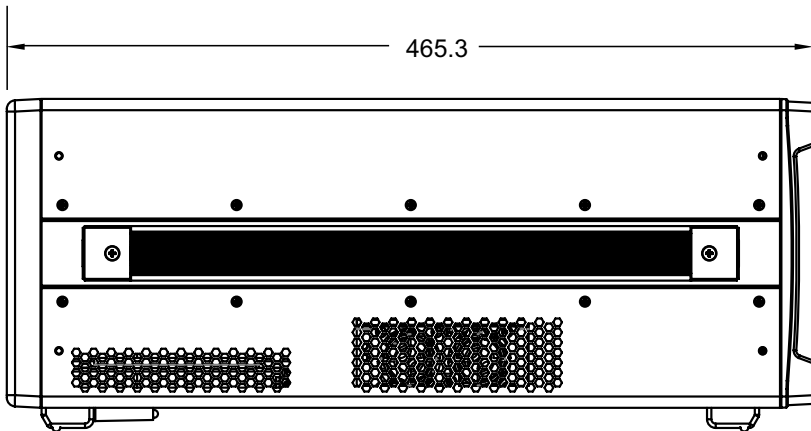


Figure 1-2: Right Side View



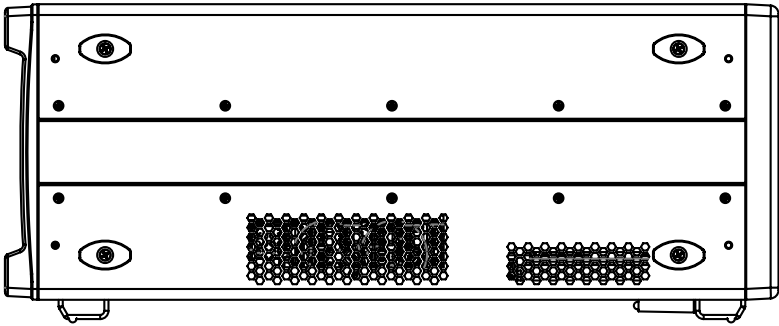


Figure 1-3: Left Side View

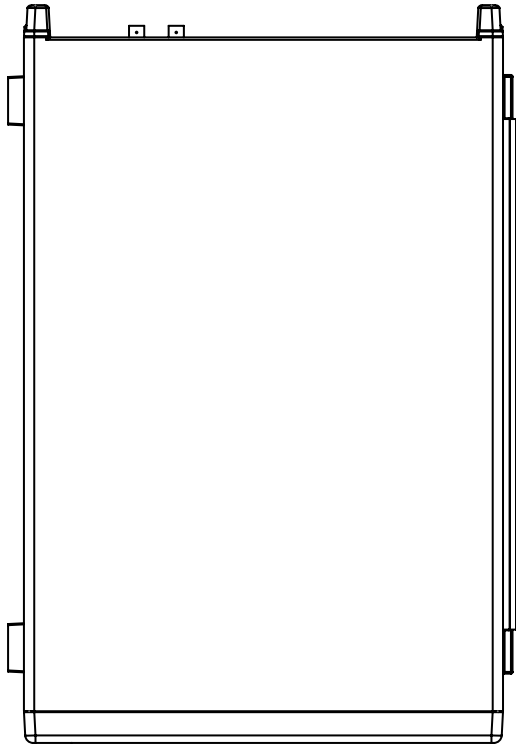
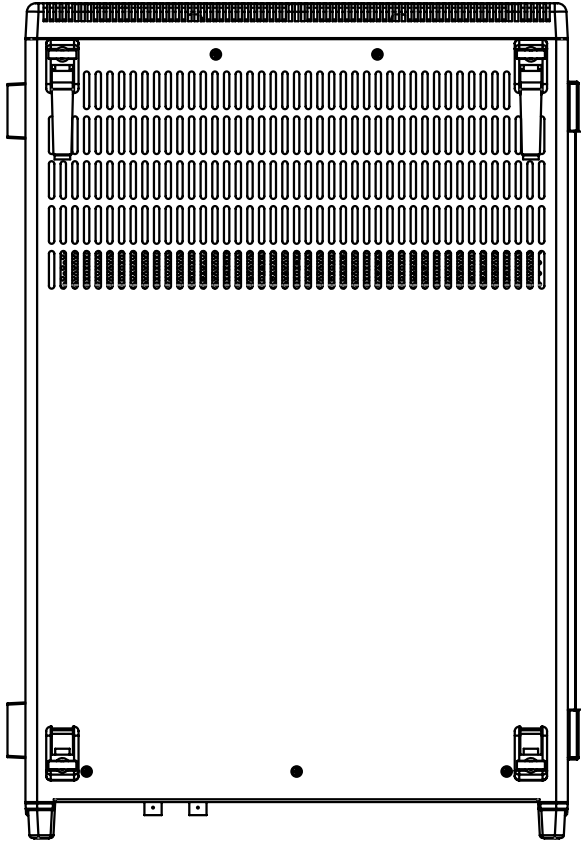


Figure 1-4: Top View



**Figure 1-5: Underside View**

## 1.4 Connectors, I/O, and Controls

### 1.4.1 Front Panel

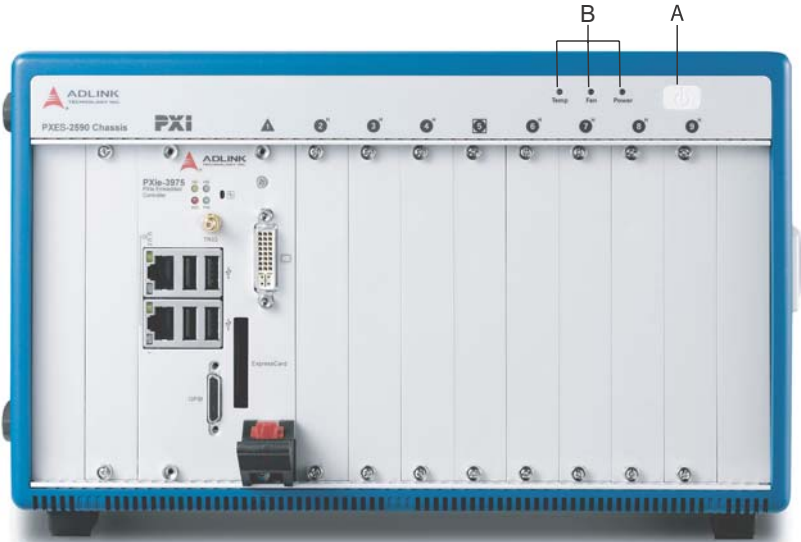


Figure 1-6: PXES-2590 Front Panel

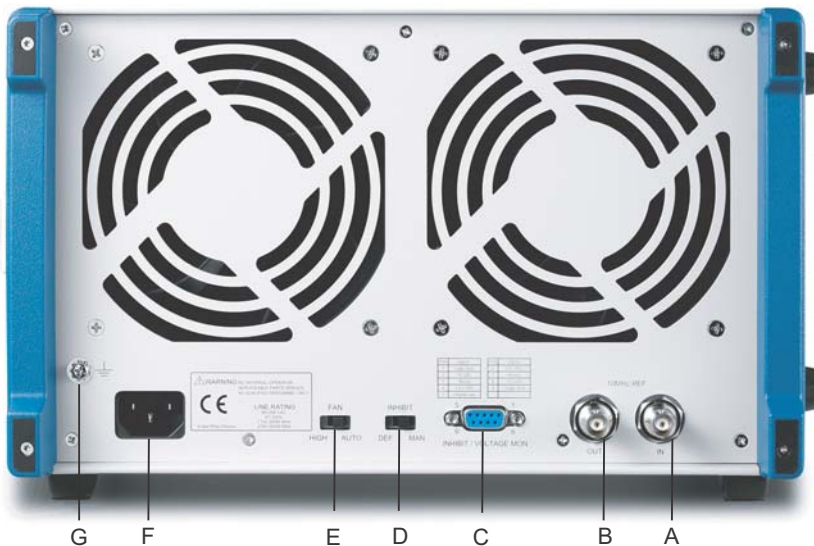
	Feature	Details
A	Power	Powers the chassis on/off (when INHIBIT on rear panel (not shown) is set to “DEF”)
B	Chassis Status	Temperature, Fan, and Power (L to R), functions as follows

Table 1-1: Front Panel Legend

Status	Temperature (Amber)	Fan (Green)	Power (Blue)
On (Lit)	N/A	Fans operating normally	DC voltage supply is normal
Off	Temperature is normal	Chassis is powered down	Chassis is powered down
Blinking	One or more temperature sensors exceeds threshold temperature (default 70°C)	One or more fans falls below threshold speed (default is 800RPM)	One or more power rails exceeds threshold settings (defaults are $\pm 5\%$ for 5V, 3.3V, +12V, and -12V)

**Table 1-2: Front Panel Indicators**

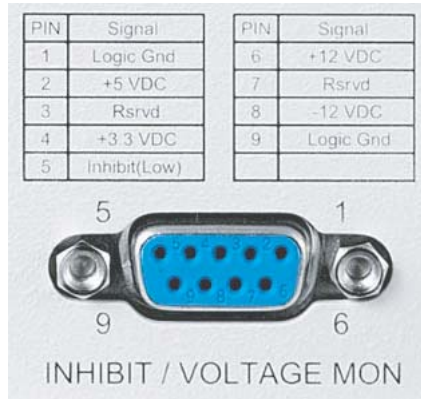
## 1.4.2 Rear Panel



**Figure 1-7: PXES-2590 Rear Panel**

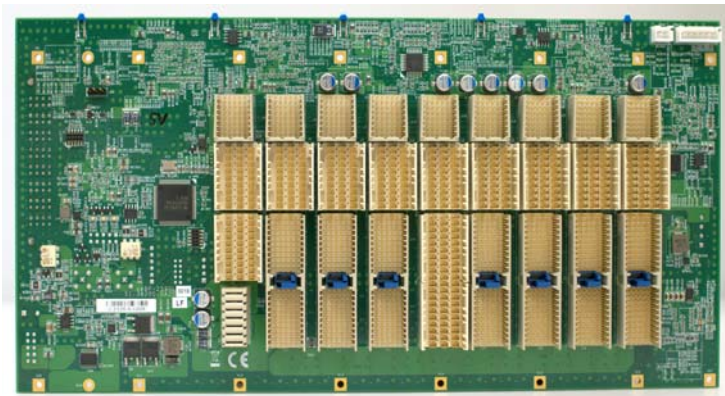
	Feature	Details
A	10MHz Reference Clock Input	The BNC connector acts as a 10MHz reference clock input, whereby the backplane 10MHz clock is overridden in the presence of an external 10MHz clock
B	10MHz Reference Clock Output	The BNC connector acts as 10MHz reference clock output
C	Inhibit/Voltage Monitoring DB-9 Connector	The DB-9 connector monitors the four main voltage rails via digital multimeter <ul style="list-style-type: none"> <li>▶ voltage rail pin assignments shown in Figure 1-8</li> <li>▶ current limiting resistors on each voltage rail prevent accidental overload</li> <li>▶ one Inhibit (active low) pin is provided to power the chassis on/off when the Inhibit Switch is in the MAN (manual) position, such that chassis is powered on when Inhibit pin is logic high or open, and off when Inhibit pin is grounded</li> </ul>
D	Inhibit Switch	In the DEF (default) position, the front panel power button turns the power supply on/off, and in the MAN (manual) position, the INHIBIT pin on the DB-9 connector turns the power supply on/off
E	Fan Switch	In the HIGH position, fans operate at maximum speed, and in AUTO, the fans run based on the monitored chassis temperature
F	Universal Power Inlet	Accepts C13 power outlet-equipped connection
G	Chassis Ground Lug	The ground wire can be crimped to the ground lug, using a crimp tool of the appropriate size, with the other end connected to ground

**Table 1-3: Rear Panel Legend**



**Figure 1-8: Inhibit/ Voltage Monitoring Connector**

### 1.4.3 Backplane



**Figure 1-9: PXES-2590 Backplane**

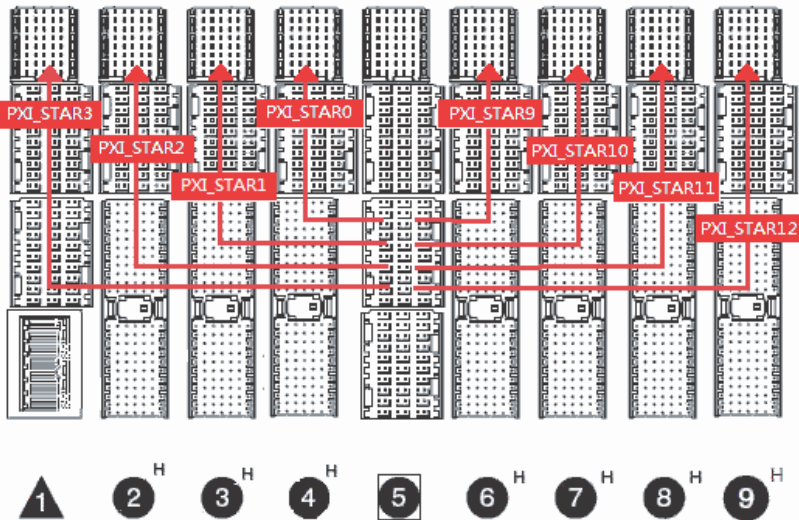
#### **PXI Express System Controller Slot**

The System Controller slot is Slot 1 of the chassis as defined by the PXI specification. The PXES-2590 chassis can accommodate a PXI Express system controller that occupies width up to 4 slots. As defined in the PXI specification, three controller expansion slots allow the controller to expand to the left to pre-

vent the controller from using up peripheral slots.

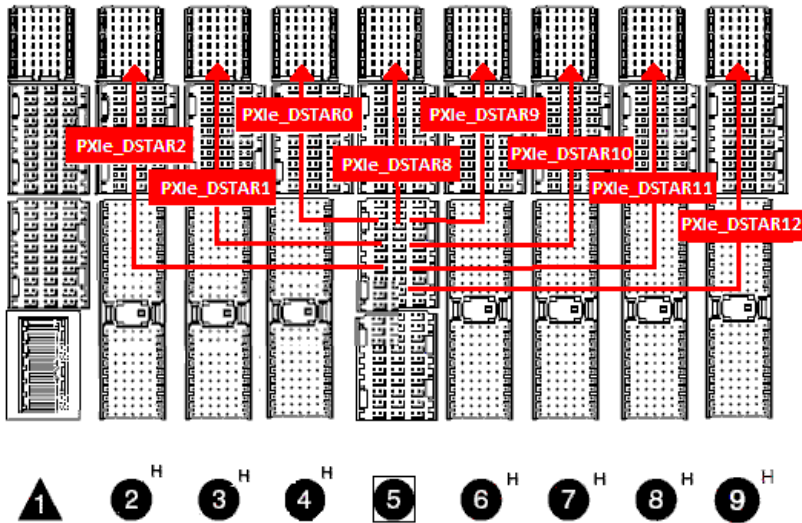
### PXI Express System Timing Slot

The System Timing (ST) slot is Slot 5, providing one dedicated single-ended star trigger and 3 pairs of differential star trigger lines to each peripheral slot. Routing of single ended star trigger signals (PXI\_STAR) is as follows



**Figure 1-10: Single-ended Star Trigger Routing**

Routing of differential star trigger signals (PXIe\_DSTAR) is as follows.



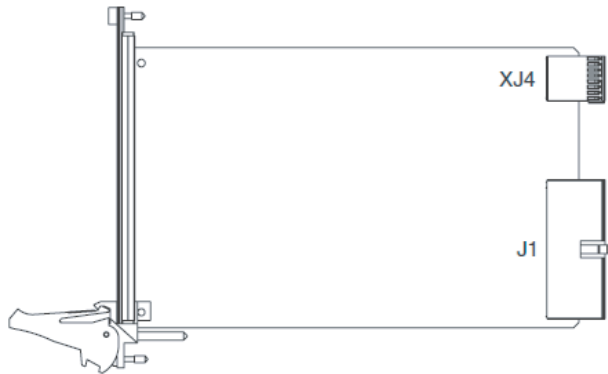
**Figure 1-11: Differential Star Trigger Routing**

Star trigger functionality provides a precise trigger signal to the peripheral modules by installation of a specific star trigger controller module in the ST slot. The star trigger slot can also be used as a general PXI Express peripheral slot if star trigger functionality is not required.

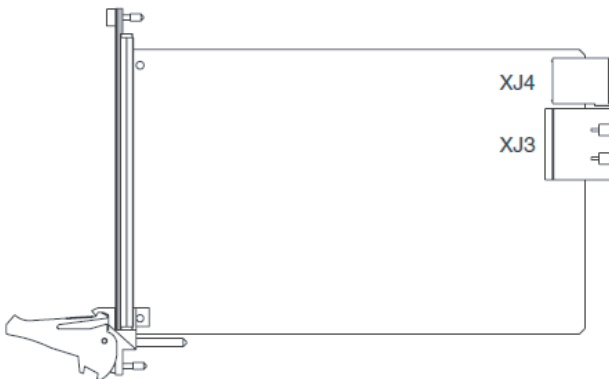
### **PXI Express Hybrid Slots**

7 peripheral slots are provided in the PXES-2590, all of which are PXI Express hybrid slots. Each can accommodate a 3U PXI Express/CompactPCI Express/ hybrid slot compatible PXI-1/CompactPCI peripheral module.





**Figure 1-12: 3U hybrid slot compatible PXI-1 peripheral module**



**Figure 1-13: 3U PXI Express peripheral module**

### Local Bus

The local bus on a PXI backplane is a daisy-chained bus that connects each peripheral slot with adjacent peripheral slots to the left and right. The quantity of local bus lines is decreased from thirteen to one on a PXI Express backplane. The remain-

ing local bus line can transmit analog or digital signals between modules.

### **Trigger Bus**

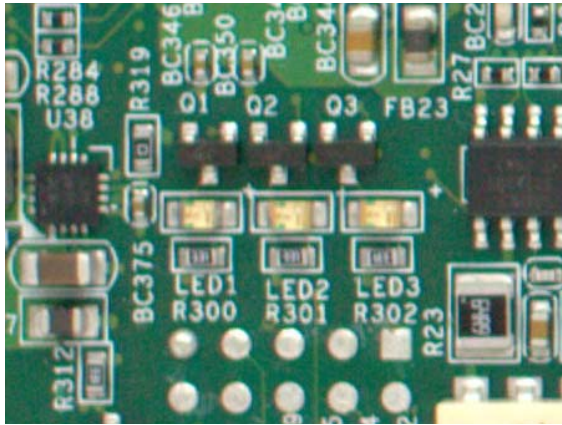
The trigger bus is an 8-line bus that connects all slots on the PXES-2590, providing inter-module synchronization. PXI and PXI Express modules can exchange trigger or clock signals through the trigger bus, allowing precisely timed response to asynchronous external events the system is monitoring or controlling.

### **Reference Clock**

The PXES-2590 backplane supplies single-ended 10MHz reference clock (PXI\_CLK10) and differential 100MHz clock (PXIe\_CLK100) to each peripheral slot for inter-module synchronization. The independent buffers drive the clock signal to each peripheral slot.

These common reference clock signals can synchronize multiple modules in a PXI Express chassis. PXI modules with phase-lock loop circuits can lock reference clocks to generate an in-phase timebase.

The PXI\_CLK10 and PXIe\_CLK100 clocks are in-phase according to the PXI-5 specification. Since the external 10MHz clock input can override the onboard 10MHz clock source, a phase-lock loop (PLL) circuit on the backplane synchronizes the PXIe\_CLK100 and external 10MHz clock. Three LED indicators on the left side of the system controller slot indicate status as follows.



**Figure 1-14: PXES-2590 Backplane Indicators**

Left LED (LED 1), VCXO present	Middle LED (LED 2), external clock present	Right LED (LED 3), phase-lock complete
Lights when the onboard VCXO is operating, should be lit at all times	Lights when external 10MHz clock is present, including from BCN connector on rear panel and from system timing slot	Lights when the external 10MHz clock is phase locked by PLL circuit

**Table 1-4: Backplane Indicator Legend**

The PXES-2590 PXI chassis automatically selects the 10 MHz reference clock source from

- ▷ Built-in accurate 10 MHz clock source
- ▷ External 10 MHz clock through a BNC connector
- ▷ PXI\_CLK10\_IN pin on the system timing slot

Priority of 10MHz reference clock is as follows

<b>System Timing Slot (5th slot)</b>	<b>BNC connector on rear panel</b>	<b>10MHz clock driven to peripheral slots</b>
No clock present	No clock present	10MHz clock is generated by backplane.
No clock present	10MHz clock present	Clock from BNC connector is driven to all peripheral slots
10MHz clock present	No clock present	Clock from system timing slot is driven to all peripheral slots
10MHz clock present	10MHz clock present	Clock from system timing slot is driven to all peripheral slots

**Table 1-5: 10MHz Reference Clock Priority**

## 2 Getting Started

This chapter describes procedures for installing the PXES-2590 and making preparations for its operation. Please contact ADLINK or authorized dealer if there are any problems during the installation.



NOTE:

Diagrams and illustrated equipment are for reference only. Actual system configuration and specifications may vary.

---

### 2.1 Package Contents

Before unpacking, check the shipping carton for any damage. If the shipping carton and/or contents are damaged, inform your dealer immediately. Retain the shipping carton and packing materials for inspection. Obtain authorization from your dealer before returning any product to ADLINK.

Please ensure that the following items are included in the package.

- ▶ PXES-2590 Chassis
- ▶ Power cords
- ▶ Filler panel kit for unused/reserved slots including one 3-slot panel and nine 1-slot panels
- ▶ ADLINK All-in-One CD
- ▶ User's Manual

If any of these items are missing or damaged, contact the dealer from whom you purchased the product. Save the shipping materials and carton in case you want to ship or store the product in the future.



Do not install or apply power to equipment that is damaged or missing components. Retain the shipping carton and packing materials for inspection. Please contact your ADLINK dealer/vendor immediately for assistance and obtain authorization before returning any product.

---

## 2.2 Cooling Considerations

The PXES-2590 features an innovative design for heat dissipation, with cooling fans in the rear section of the chassis, drawing cool air through apertures on the bottom for exhaust through the back. This design provides uniform airflow for each PXI slot and exceptional cooling capability. When the chassis is installed in a rack, the cooling design minimizes drawing of hot air from the rear area, where other devices exhaust, while maintaining a steady temperature inside the chassis. For optimal cooling efficiency, retain support feet.

When rack mounting the PXES-2590, at least 1U (44.5 mm/1.75 in.) clearance below the intake apertures is required. Also keep other objects or equipment at a minimum of 76.2 mm (3 in.) away from the outlet apertures in the rear region of the chassis.



NOTE:

To maintain expected air flow, always install filler panels in unused slots. The filler panels can be found in the chassis package.

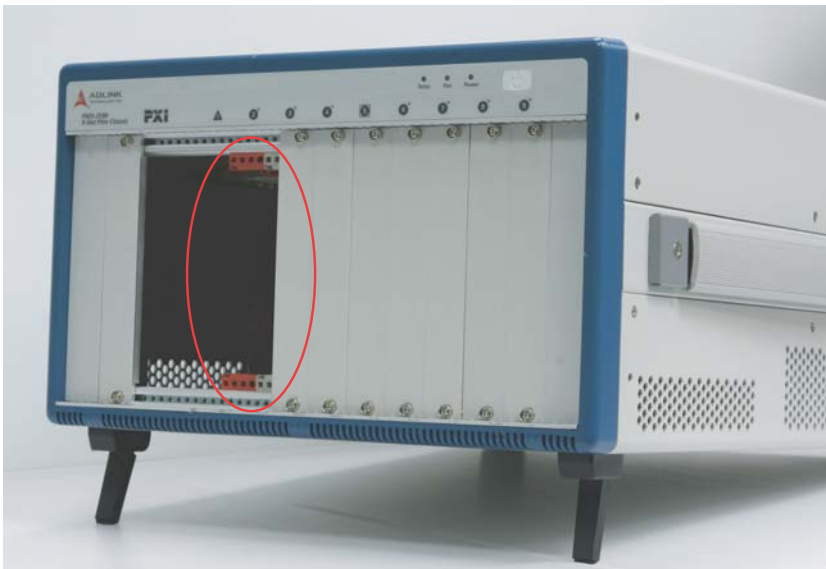
---

## 2.3 Hardware Installation

### 2.3.1 Installing the System Controller

The PXES-2590 incorporates a system controller slot supporting a PXI Express system controller of 3 or 4 slot width. We recommend the ADLINK PXIe-3975 Core™ i5-520E Controller for use with the PXES-2590.

1. Ensure the CPU, memory module(s), and storage device(s) are properly installed on the system controller.
2. Locate the system controller slot (Slot 1).



3. Depress the system controller module's latch to release.

4. Align the module's top and bottom edges with the card guides, and carefully slide the module into the chassis.



5. Lift the latch until the module is securely seated in the chassis backplane.



6. Fasten the screws on the module front panel, and connect all devices to the system controller.





### 2.3.2 Installing Peripheral Modules

The PXE-2590 supports up to eight peripheral modules, including a system timing module.

1. Select an available peripheral slot (2 to 9)
2. Depress the peripheral module's latch and align the module's top and bottom edges with the card guides.

3. Carefully slide the module into the chassis.



4. Lift the latch until the module is securely seated in the chassis backplane.



5. Fasten the screws on the module's front panel.



6. Repeat steps 1 to 5 to install additional PXI peripheral modules.



NOTE:

To improve efficiency of heat dissipation, after installing all PXI modules, please install filler plates for any unused slots.

### **2.3.3 Powering Up the System**

The PXES-2590 is equipped with a 100 VAC to 240 VAC universal power supply unit requiring no input voltage selection.

1. Connect one end of the supplied power cord to the power inlet located at the rear side of the chassis.
2. Plug the other end of the AC power cord to a properly grounded wall socket or power strip.
3. Press the standby power switch. The Power LED (blue) lights up immediately
4. To power off the chassis, press the standby power switch.

## 3 System Management

The PXES-2590 chassis provides advanced system monitoring and control. Chassis conditions, including internal temperature, fan speed, and DC voltage, are exported via smbus, allowing detailed chassis status to be monitored on the system controller.

### 3.1 Installing the Monitor Utility



The FTP monitor utility can only be used with an ADLINK PXI Express controller. A customized utility is required for use with a 3rd party embedded controller. Please see Section 4.3: Function Library if development of a customized utility is desired.

---

The remote monitoring utility and function library are provided on the ADLINK All-in-One CD.

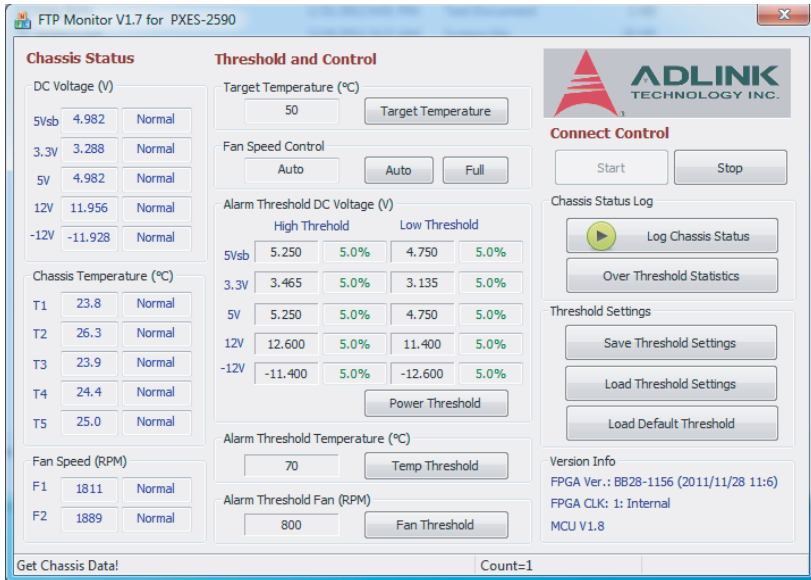
To install the monitoring utility:

1. Connect a USB CD-/DVD-ROM drive to the system controller.
2. Place the ADLINK All-in-One CD in the drive.
3. Locate the monitoring utility in the folder  
X:\Driver Installation\PXI Platform\PXI chassis\PXES-2590\FTP Monitor\_PXES2590\_V1.7.exe\  
(where X: denotes the CD-ROM drive)
4. Double-click **FTP Monitor\_PXES2590\_V1.7.exe** to begin installation.

### 3.2 Monitoring the PXES-2590

ADLINK provides a GUI program:  
**(FTP Monitor\_PXES2590\_V1.7.exe)**  
to monitor the status of the PXES-2590.

As shown, the utility is divided into three interface categories: Connect Control, Threshold & Control, and Chassis Status.



**Figure 3-1: FTP Monitor Interface**

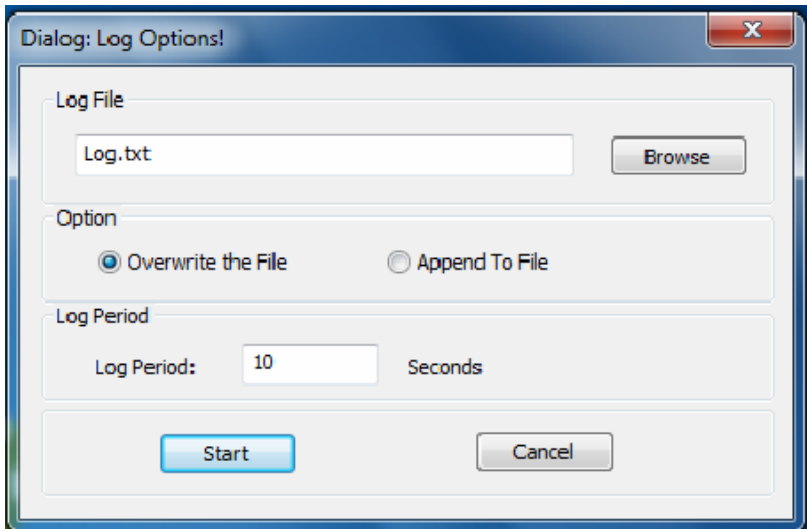
## 3.2.1 Connect Control

### Start/Stop Monitoring

Selecting Start initializes monitoring, and selecting Stop ends the operation.

### Chassis Status Log

With the Chassis Status Log function, monitored data can be recorded. Clicking Log Chassis Status opens the Log Options dialog, as shown.



Command	Details
Log File	Path and name for log file.
Option	When a log file exists and logging commences, replaces (overwrites) the current file or appends new data into the file.
Log Period	Interval between data logging.

**Table 3-1: Log Options Commands**

### Over Threshold Statistics

When selected, displays over threshold statistics.

### Save/Load Threshold

All Threshold & Control settings can be saved or loaded here. Clicking Save Threshold Settings saves all current settings. Clicking Load Threshold Settings loads all settings from the saved file. Clicking Load Default Threshold resets all threshold settings to the default values.

## Version Info

Displays the current firmware version and 10MHz clock source.

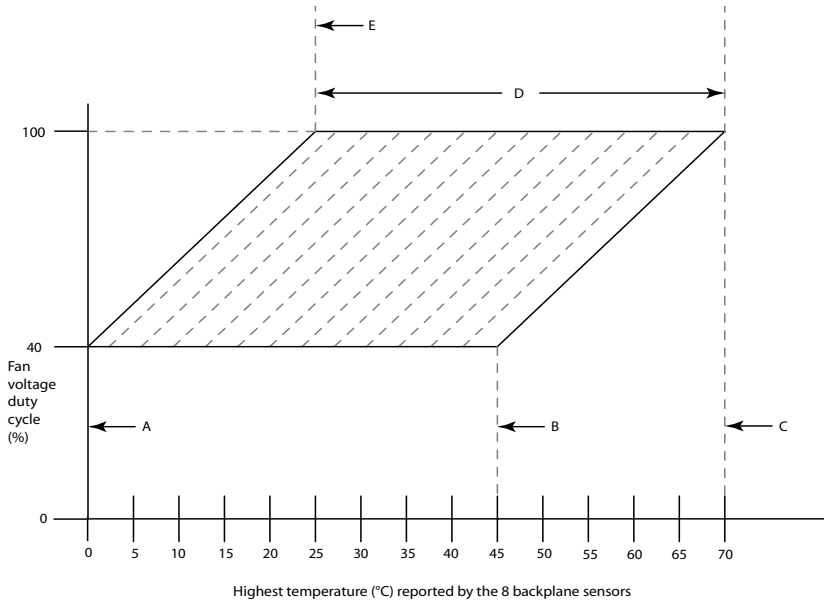
### 3.2.2 Threshold and Control

Provides operational and threshold settings for the PXES-2590, including target temperature, fan mode, and threshold settings for DC voltage, temperature, and cooling fan speeds.

#### Target Temperature

Fans run at different speeds based on the monitored temperature, when the Fan switch on the rear panel is set to AUTO. Target Temp indicates the temperature when the fans are at 100%. Using the default 50°C as an example, fans run at 40% when all temperature readings are less than 25°C, and begin rampup when any reading exceeds 25°C. The fans run 100% speed if any temperature reading exceeds 50°C (Target Temperature). Target temperature setting parameters are as shown.





	Temperature	Event
A	0°C	Lowest chassis temperature at which fan speeds commence ramping up for final 25° temperature mark (see Item E)
B	45°	Highest chassis temperature at which fan speeds commence ramping up for final 70° temperature mark (see Item C)
C	70°	Highest maximum chassis temperature at which the fans reach maximum speed
D	25°C to 70°C (45 degree range)	Range over which maximum chassis temperature (at which fans reach maximum speed) can be set
E	25°C	Lowest maximum chassis temperature at which fans reach maximum speed

**Figure 3-2: Target Temperature Parameters and Legend**

Target Temp can be set by entering the desired target temperature value in the field and clicking Set.

## **Fan Speed**

Auto/Full status of the PXES-2590 is shown here, Auto is displayed when the cooling fans are set to auto mode and Full when the fans are set to run full speed. Selection of Auto or Full values and clicking Set directly changes cooling fan mode.

## **Alarm Threshold**

Active alarm threshold settings are shown, including DC voltage, temperature, and fan speeds. The updated threshold setting can also be set here, by entering the desired value and clicking Set Threshold Settings.

### **3.2.3 Chassis Status**

#### **DC Voltage**

The monitored 5V AUX, 3.3V, 5V, 12V, and -12V power rail readings are shown here. The status shows as normal when the readings are within the threshold range, and abnormal when the readings exceed the threshold range.

#### **Chassis Temperature**

Temperature sensors T1 to T5 located on the backplane from left to right provide status, showing as normal when under the threshold value (70°C in the figure), and abnormal when exceeding the threshold value.

#### **Fan Speed**

Monitored readings of the three cooling fans appear here. Status shows as normal when readings exceed threshold value (800 RPM in the figure), and abnormal when the readings fall below the threshold value.

## 4 Monitoring/Control Functions

The monitoring/control function library can be used to create a customized program for monitoring and controlling the PXES-2590. The smbus interface on the system controller provides access to system monitoring functions, including:

- ▶ Read backplane/chassis data such as power/temperature/fan speed
- ▶ Set thresholds for power/temperature/fan
- ▶ Read firmware version
- ▶ Set fan speeds

The following abbreviations are used in this chapter:

MA	Master Address
MCU	Microcontroller on backplane.
SA	Slave Address (= 0x32)
SC	System controller located in slot 1
SMB	System Management Bus

### 4.1 SMBus API

The PXES-2590 SMBus slave address of the system monitoring function is 0xC6h.

### 4.2 Function Overview

The following table shows all commands to access monitored data

Command	Function	Access
0x02	Read Alarm Status	R
0x04	Read 5V Voltage	R
0x06	Read 3.3V Voltage	R
0x08	Read +12V Voltage	R
0x0A	Read -12V Voltage	R
0x0C	Read 5Vsb Voltage	R
0x10	Read Temperature 1	R
0x12	Read Temperature 2	R
0x14	Read Temperature 3	R

Command	Function	Access
0x16	Read Temperature 4	R
0x18	Read Temperature 5	R
0x20	Read Fan Speed 1	R
0x22	Read Fan Speed 2	R
0x24	Read Fan Speed 3	R
0x26	Read MCU code version	R
0x30	Read Target Chassis Temperature	R
0x44	Read Fan Speed Mode	R
0x46	Block Read Chassis Data Part 1	BR
0x47	Block Read Chassis Data Part 2	BR
0xB0	Write Target Chassis Temperature	W
0xB2	Write 5V Alarm Threshold	W
0xB4	Write 3.3V Alarm Threshold	W
0xB6	Write +12V Alarm Threshold	W
0xB8	Write -12V Alarm Threshold	W
0xBA	Write 5Vsb Alarm Threshold	W
0xBC	Write Fan Speed Alarm Threshold	W
0xBE	Write Temperature Alarm Threshold	W
0xC0	Write to Default Threshold	W
0xC2	Reset MCU	W
0xC4	Write Fan Speed Mode	W

**Table 4-1: PXES-2590 Functions**

## 4.3 Function Library

### \*Read Alarm Status (command 0x02)

Reads alarm status from the monitoring unit

Use the SMB 1 Send Byte and 2 Receive Byte to read this word data:

SMB	Dir	Offset	Value	Description
Send Byte	>	0	SA	Slave address
	>	1	0x02	command code

SMB	Dir	Offset	Value	Description
Receive Byte	>	2	SA	Slave address
	<	3	0-255	Low byte data
Receive Byte	>	4	SA	Slave address
	<	5	0-255	High byte data

Data format is as follows:

Bit	Description	Default
0	Voltage Alarm. MCU writes 1 to indicate voltage thresholds crossed.	0
1	Temperature Alarm. MCU writes 1 to indicate over temperature occurred.	0
2	Fan Speed Alarm. MCU writes 1 to indicate fan speed alarm is triggered.	0
3	3.3V Alarm. MCU writes 1 to indicate 3.3V out of specified range.	0
4	5V Alarm. MCU writes 1 to indicate 5V out of specified range.	0
5	-12V Alarm. MCU writes 1 to indicate -12V out of specified range.	0
6	+12V Alarm. MCU writes 1 to indicate +12V out of specified range.	0
7	5Vsb Alarm. MCU writes 1 to indicate 5V standby out of specified range.	0
15..8	Reserved.	0

### \*Read 5V Voltage (command 0x04)

Reads 5V Voltage

Use the SMB 1 Send Byte and 2 Receive Byte to Read this word data:

SMB	Dir	Offset	Value	Description
Send Byte	>	0	SA	Slave address
	>	1	0x04	command code
Receive Byte	>	2	SA	Slave address
	<	3	0-255	Low byte data

SMB	Dir	Offset	Value	Description
Receive Byte	>	4	SA	Slave address
	<	5	0-255	High byte data

Data format is as follows:

Bit	Description
15..0	5V Voltage. Measured 5V voltage. 16-bit 2's complement , the LSB is 1mV

### \*Read 3.3V Voltage (command 0x06)

Reads the 3.3V Voltage

Use the SMB 1 Send Byte and 2 Receive Byte to Read this word data:

SMB	Dir	Offset	Value	Description
Send Byte	>	0	SA	Slave address
	>	1	0x06	command code
Receive Byte	>	2	SA	Slave address
	<	3	0-255	Low byte data
Receive Byte	>	4	SA	Slave address
	<	5	0-255	High byte data

Data format is as follows:

Bit	Description
15..0	3.3V Voltage. Measured 3.3V voltage. 16-bit 2's complement , the LSB is 1mV

**\*Read +12V Voltage (command 0x08)**

Reads the +12V Voltage

Use the SMB 1 Send Byte and 2 Receive Byte to Read this word data:

Send Byte	>	0	SA	Slave address
	>	1	0x08	command code
Receive Byte	>	2	SA	Slave address
	<	3	0-255	Low byte data
Receive Byte	>	4	SA	Slave address
	<	5	0-255	High byte data

Data format is as follows:

Bit	Description
15..0	+12V Voltage. Measured +12V voltage. 16-bit 2's complement , the LSB is 1mV

**\*Read -12V Voltage (command 0x0A)**

Reads the -12V Voltage

Use the SMB 1 Send Byte and 2 Receive Byte to Read this word data:

SMB	Dir	Offset	Value	Description
Send Byte	>	0	SA	Slave address
	>	1	0x0A	Command code
Receive Byte	>	2	SA	Slave address
	<	3	0-255	Low byte data
Receive Byte	>	4	SA	Slave address
	<	5	0-255	High byte data

Data format is as follows:

Bit	Description
15..0	-12V Voltage. Measured -12V voltage. 16-bit 2's complement, the LSB is 1mV

### \*Read 5Vsb Voltage ( command 0x0C)

Reads the 5Vsb Voltage

Use the SMB 1 Send Byte and 2 Receive Byte to Read this word data:

SMB	Dir	Offset	Value	Description
Send Byte	>	0	SA	Slave address
	>	1	0x0C	command code
Receive Byte	>	2	SA	Slave address
	<	3	0-255	Low byte data
Receive Byte	>	4	SA	Slave address
	<	5	0-255	High byte data

Data format is as follows:

Bit	Description
15..0	5Vsb Voltage. Measured 5V standby voltage. 16-bit 2's complement, the LSB is 1mV

### \*Read Temperature 1 (command 0x10)

Reads the Temperature 1 Reading.

Use the SMB 1 Send Byte and 2 Receive Byte to Read this word data.:

SMB	Dir	Offset	Value	Description
Send Byte	>	0	SA	Slave address
	>	1	0x10	Command code
Receive Byte	>	2	SA	Slave address
	<	3	0-255	Low byte data
Receive Byte	>	4	SA	Slave address
	<	5	0-255	High byte data



Data format is as follows:

Bit	Description
15..0	5Vsb Voltage. Measured 5V standby voltage. 16-bit 2's complement, the LSB is 1mV °C

### \*Read Temperature 2 (command 0x12)

Reads the Temperature 2 Reading.

Use the SMB 1 Send Byte and 2 Receive Byte to Read this word data:

SMB	Dir	Offset	Value	Description
Send Byte	>	0	SA	Slave address
	>	1	0x12	command code
Receive Byte	>	2	SA	Slave address
	<	3	0-255	Low byte data
Receive Byte	>	4	SA	Slave address
	<	5	0-255	High byte data

Data format is as follows:

Bit	Description
15..0	Temperature 2. 16-bit data, 2's complement, LSB is 0.1°C

### \*Read Temperature 3 (command 0x12)

Reads the Temperature 3 Reading.

Use the SMB 1 Send Byte and 2 Receive Byte to Read this word data:

SMB	Dir	Offset	Value	Description
Send Byte	>	0	SA	Slave address
	>	1	0x14	command code
Receive Byte	>	2	SA	Slave address
	<	3	0-255	Low byte data

SMB	Dir	Offset	Value	Description
Receive Byte	>	4	SA	Slave address
	<	5	0-255	High byte data

Data format is as follows:

Bit	Description
15..0	Temperature 3. 16-bit data, 2's complement, LSB is 0.1°C

### \*Read Temperature 3 (command 0x14)

Reads the Temperature 3 Reading.

Use the SMB 1 Send Byte and 2 Receive Byte to Read this word data:

SMB	Dir	Offset	Value	Description
Send Byte	>	0	SA	Slave address
	>	1	0x16	Command code
Receive Byte	>	2	SA	Slave address
	<	3	0-255	Low byte data
Receive Byte	>	4	SA	Slave address
	<	5	0-255	High byte data

Data format is as follows:

Bit	Description
15..0	Temperature 4. 16-bit data, 2's complement, LSB is 0.1°C

**\*Read Temperature 4 (command 0x16)**

Reads the Temperature 4 Reading.

Use the SMB 1 Send Byte and 2 Receive Byte to Read this word data:

SMB	Dir	Offset	Value	Description
Send Byte	>	0	SA	Slave address
	>	1	0x16	command code
Receive Byte	>	2	SA	Slave address
	<	3	0-255	Low byte data
Receive Byte	>	4	SA	Slave address
	<	5	0-255	High byte data

Data format is as follows:

Bit	Description
15..0	Temperature 4. 16-bit data, 2's complement, LSB is 0.1°C

**\*Read Temperature 5 (command 0x18)**

Reads the Temperature 5 Reading.

Use the SMB 1 Send Byte and 2 Receive Byte to Read this word data:

SMB	Dir	Offset	Value	Description
Send Byte	>	0	SA	Slave address
	>	1	0x18	Command code
Receive Byte	>	2	SA	Slave address
	<	3	0-255	Low byte data
Receive Byte	>	4	SA	Slave address
	<	5	0-255	High byte data

Data format is as follows:

Bit	Description
15..0	Temperature 5. 16-bit data, 2's complement, LSB is 0.1°C

### \*Read Fan Speed 1 (command 0x20)

Reads the Fan Speed 1 Reading.

Use the SMB 1 Send Byte and 2 Receive Byte to Read this word data:

SMB	Dir	Offset	Value	Description
Send Byte	>	0	SA	Slave address
	>	1	0x20	Command code
Receive Byte	>	2	SA	Slave address
	<	3	0-255	Low byte data
Receive Byte	>	4	SA	Slave address
	<	5	0-255	High byte data

Data format is as follows:

Bit	Description
15..0	Fan 1 Speed. Unsigned 16-bit data, the LSB is 1 rpm

### \*Read Fan Speed 2 (command 0x22)

Reads the Fan Speed 2 Reading.

Use the SMB 1 Send Byte and 2 Receive Byte to Read this word data:

SMB	Dir	Offset	Value	Description
Send Byte	>	0	SA	Slave address
	>	1	0x22	Command code
Receive Byte	>	2	SA	Slave address
	<	3	0-255	Low byte data
Receive Byte	>	4	SA	Slave address
	<	5	0-255	High byte data

Data format is as follows:

Bit	Description
15..0	Fan 2 Speed. Unsigned 16-bit data, the LSB is 1 rpm

**\*Read Fan Speed 3 (command 0x24)**

Reads the Fan Speed 3 Reading.

Use the SMB 1 Send Byte and 2 Receive Byte to Read this word data:

SMB	Dir	Offset	Value	Description
Send Byte	>	0	SA	Slave address
	>	1	0x24	Command code
Receive Byte	>	2	SA	Slave address
	<	3	0-255	Low byte data
Receive Byte	>	4	SA	Slave address
	<	5	0-255	High byte data

Data format is as follows:

Bit	Description
15..0	Fan 3 Speed. Unsigned 16-bit data, the LSB is 1 rpm

**\*Read MCU Code Version (command 0x26)**

Reads the MCU Code Version.

Use the SMB 1 Send Byte and 2 Receive Byte to Read this word data:

SMB	Dir	Offset	Value	Description
Send Byte	>	0	SA	Slave address
	>	1	0x26	Command code
Receive Byte	>	2	SA	Slave address
	<	3	0-255	Low byte data
Receive Byte	>	4	SA	Slave address
	<	5	0-255	High byte data

Data format is as follows:

Bit	Description
7..0	MCU FW version minor number, Unsigned 8-bit data
15..8	MCU FW version major number, Unsigned 8-bit data

### \*Read Target Chassis Temperature (command 0x30)

Reads the Target Chassis Temperature.

Use the SMB 1 Send Byte and 2 Receive Byte to Read this word data:

SMB	Dir	Offset	Value	Description
Send Byte	>	0	SA	Slave address
	>	1	0x30	Command code
Receive Byte	>	2	SA	Slave address
	<	3	0-255	Low byte data
Receive Byte	>	4	SA	Slave address
	<	5	0-255	High byte data

Data format is as follows:

Bit	Description
7..0	Maximum chassis temperature setting. Unsigned 8-bit data, the LSB is 1°C. The CPU can set the temperature at which maximum fan speed is achieved. The system monitoring MCU adjusts the fan speed according to this setting. The threshold range is between 25 and 70
15..8	Reserved.

### \*Read Fan Speed Mode (command 0x44)

Reads the Fan Speed Mode.

Use the SMB 1 Send Byte and 2 Receive Byte to Read this word data:

SMB	Dir	Offset	Value	Description
Send Byte	>	0	SA	Slave address
	>	1	0x44	Command code
Receive Byte	>	2	SA	Slave address
	<	3	0-255	Low byte data
Receive Byte	>	4	SA	Slave address
	<	5	0-255	High byte data

Data format is as follows:

Bit	Description
15..0	Fan Speed Mode: 0: Auto 1: Full Speed 2: Low Speed

### \*Block Read Chassis Data Part 1 (command 0x46)

Block reads the Chassis Data Structure Part 1.

Use the SMB Block Read to Read this data structure.



Use command 0x46 first, then command 0x47 to acquire the entire data structure.

NOTE:

SMB	Dir	Offset	Value	Description
Block Read	>	0	SA	Slave address
	>	1	0x46	Command code
	>	2	SA	Slave address
	>	3	26	Byte count
	>	4~31	0-255	Data Structure upper part

Data Format Description:

The entire Chassis Data Structure is as:

```
typedef struct st_BlockRead
```

```
{
    INT16 P_5V;
    INT16 P_3V3;
    INT16 P_5Vsb;
    INT16 P_12V;
    INT16 P_N12V;
    INT16 T1;
    INT16 T2;
    INT16 T3;
    INT16 T4;
```

```
INT16 T5;  
UINT16 F1;  
UINT16 F2;  
UINT16 F3;  
UINT16 MCU_Version;  
UINT16 FAN_Mode;  
UINT16 Max_Chassis_Temp;  
UINT16 Threshold_5V;  
UINT16 Threshold_3V3;  
UINT16 Threshold_12V;  
UINT16 Threshold_N12V;  
UINT16 Threshold_5Vsb;  
UINT16 Threshold_Fan;  
UINT16 Threshold_Temp;  
UINT16 ErrorCheck;  
} ST_BlockRead;  
Part 1:  
INT16 P_5V;// DC 5V Unit : 1mV  
INT16 P_3V3;// DC 3.3V Unit : 1mV  
INT16 P_5Vsb; // DC 5Vsb Unit : 1mV  
INT16 P_12V; // DC 12V Unit : 1mV  
INT16 P_N12V;// DC -12V Unit : 1mV  
INT16 T1;// Temperature 1, Unit :0.1°C  
INT16 T2; // Temperature 2, Unit :0.1°C  
INT16 T3; // Temperature 3, Unit :0.1°C  
INT16 T4; // Temperature 4, Unit :0.1°C  
INT16 T5; // Temperature 5, Unit :0.1°C  
UINT16 F1;// Fan Speed 1, Unit rpm  
UINT16 F2; // Fan Speed 2, Unit rpm
```



**\*Block Read Chassis Data Part 2 (command 0x47)**

Block reads the Chassis Data Structure Part 2.

Use the SMB Block Read to Read this data structure.



NOTE:

Use command 0x46 first, then command 0x47 to acquire the entire data structure.

---

**Data Format Description:**

The whole Chassis Data Structure is as

typedef struct st\_BlockRead

```
{
INT16 P_5V;
INT16 P_3V3;
INT16 P_5Vsb;
INT16 P_12V;
INT16 P_N12V;
INT16 T1;
INT16 T2;
INT16 T3;
INT16 T4;
INT16 T5;
UINT16 F1;
UINT16 F2;
UINT16 F3;
UINT16 MCU_Version;
UINT16 FAN_Mode;
UINT16 Max_Chassis_Temp;
UINT16 Threshold_5V;
UINT16 Threshold_3V3;
UINT16 Threshold_12V;
```

```
UINT16 Threshold_N12V;  
UINT16 Threshold_5Vsb;  
UINT16 Threshold_Fan;  
UINT16 Threshold_Temp;  
UINT16 ErrorCheck;  
} ST_BlockRead;
```

Part 2 is:

```
UINT16 F3; // Fan Speed 3, Unit rpm  
UINT16 MCU_Version; // MCU Version format as in command  
0x26  
UINT16 FAN_Mode; // Fan Speed Mode format as in command  
0x44  
UINT16 Max_Chassis_Temp; // Target Chassis Temperature,  
Unit°C  
UINT16 Threshold_5V; // 5V Threshold, format as in command  
0xB2  
UINT16 Threshold_3V3; // 3.3V Threshold, format as in com-  
mand 0xB4  
UINT16 Threshold_12V; // 12V Threshold, format as in com-  
mand 0xB6  
UINT16 Threshold_N12V; // -12V Threshold, format as in com-  
mand 0xB8  
UINT16 Threshold_5Vsb; // 5V Threshold, format as in com-  
mand 0xB2  
UINT16 Threshold_Fan; // Fan Speed Threshold, Unit : rpm  
UINT16 Threshold_Temp; // Temperature, Unit°C  
UINT16 ErrorCheck; // ErrorCheck = 0xBABA – (sum of struc-  
ture word 0~24);
```

**\*Write Target Chassis Temperature (command 0xB0)**

Writes the Target Chassis Temperature.

Use the SMB write word to write this word data

SMB	Dir	Offset	Value	Description
Write word	>	0	SA	Slave address
	>	1	0xB0	Command code
	>	2	0-255	Low byte data
	>	3	0-255	High byte data

Data format is as follows:

Bit	Description
7..0	Target chassis temperature setting. Unsigned 8-bit data, the LSB is 1°C. The CPU can set the temperature at which maximum fan speed is achieved. The system monitoring MCU adjusts the fan speed according to this setting. The threshold range is between 25 and 70
15..8	Reserved.

**\*Write 5V Alarm Threshold (command 0xB2)**

Writes the 5V Alarm Threshold.

Use the SMB write word to write this word data:

SMB	Dir	Offset	Value	Description
Write word	>	0	SA	Slave address
	>	1	0xB2	Command code
	>	2	0-255	Low byte data
	>	3	0-255	High byte data

Data format is as follows:

7..0	5V Under Voltage Alarm Threshold. Unsigned 8-bit data, the LSB is 0.1%. If the 5V voltage falls below the threshold, the MCU triggers a voltage alarm. For example, if the under voltage threshold is set to 5%, when the 5V is lower than $5V \cdot 0.95$ (4.75V), the MCU triggers voltage alarm. The threshold range is between 0 and 250
15..8	5V Over Voltage Alarm Threshold. Unsigned 8-bit data, the LSB is 0.1%. If the 5V voltage is higher than this threshold, the MCU triggers a voltage alarm. For example, if the over voltage threshold is set to 5%, when the 5V is higher than $5V \cdot 1.05$ (5.25V), the MCU triggers voltage alarm. The threshold range is between 0 and 250

#### **\*Write 3.3V Alarm Threshold (command 0xB4)**

Writes the 3.3V Alarm Threshold.

Use the SMB write word to write this word data:

SMB	Dir	Offset	Value	Description
Write word	>	0	SA	Slave address
	>	1	0xB4	Command code
	>	2	0-255	Low byte data
	>	3	0-255	High byte data

Data format is as follows:

Bit	Description
7..0	3.3V Under Voltage Alarm Threshold. Unsigned 8-bit data, the LSB is 0.1%. If the 3.3V voltage is lower than this threshold, the MCU triggers a voltage alarm. The threshold range is between 0 and 250
15..8	3.3V Over Voltage Alarm Threshold. Unsigned 8-bit data, the LSB is 0.1%. If the 3.3V voltage is higher than this threshold, the MCU triggers a voltage alarm. The threshold range is between 0 and 250

**\*Write +12V Alarm Threshold (command 0xB6)**

Writes the +12V Alarm Threshold.

Use the SMB write word to write this word data

SMB	Dir	Offset	Value	Description
Write word	>	0	SA	Slave address
	>	1	0xB6	Command code
	>	2	0-255	Low byte data
	>	3	0-255	High byte data

Data format is as follows:

Bit	Description
7..0	+12V Under Voltage Alarm Threshold. Unsigned 8-bit data, the LSB is 0.1%. If the +12V voltage is lower than this threshold, the MCU triggers a voltage alarm. The threshold range is between 0 and 250
15..8	+12V Over Voltage Alarm Threshold. Unsigned 8-bit data, the LSB is 0.1%. If the +12V voltage is higher than this threshold, the MCU triggers a voltage alarm. The threshold range is between 0 and 250

**\*Write -12V Alarm Threshold (command 0xB8)**

Writes the -12V Alarm Threshold.

Use the SMB write word to write this word data

SMB	Dir	Offset	Value	Description
Write word	>	0	SA	Slave address
	>	1	0xB8	Command code
	>	2	0-255	Low byte data
	>	3	0-255	High byte data

Data format is as follows:

Bit	Description
7..0	-12V Under Voltage Alarm Threshold. Unsigned 8-bit data, the LSB is 0.1%. If the -12V voltage is lower than this threshold, the MCU triggers a voltage alarm. The threshold range is between 0 and 250
15..8	-12V Over Voltage Alarm Threshold. Unsigned 8-bit data, the LSB is 0.1%. If the -12V voltage is higher than this threshold, the MCU triggers a voltage alarm. The threshold range is between 0 and 250

#### **\*Write 5Vsb Alarm Threshold (command 0xBA)**

Writes the 5Vsb Alarm Threshold.

Use the SMB write word to write this word data

SMB	Dir	Offset	Value	Description
Write word	>	0	SA	Slave address
	>	1	0xBA	Command code
	>	2	0-255	Low byte data
	>	3	0-255	High byte data

Data format is as follows:

Bit	Description
7..0	5Vsb Under Voltage Alarm Threshold. Unsigned 8-bit data, the LSB is 0.1%. If the 5V standby voltage is lower than this threshold, the MCU triggers a voltage alarm. The threshold range is between 0 and 250
15..8	5Vsb Over Voltage Alarm Threshold. Unsigned 8-bit data, the LSB is 0.1%. If the 5V standby voltage is higher than this threshold, the MCU triggers a voltage alarm. The threshold range is between 0 and 250

#### **\*Write Fan Speed Alarm Threshold (command 0xBC)**

Writes the Fan Speed Alarm Threshold.

Use the SMB write word to write this word data:

SMB	Dir	Offset	Value	Description
Write word	>	0	SA	Slave address
	>	1	0xBC	Command code
	>	2	0-255	Low byte data
	>	3	0-255	High byte data

Data format is as follows::

Bit	Description
15..0	Fan Speed Alarm Threshold. Unsigned 16-bit data, the LSB is 1rpm. If any of the fan speed is lower than this threshold, the MCU triggers a fan speed alarm. The threshold range is between 1 and 10000

#### \*Write Temperature Alarm Threshold (command 0xBE)

Writes the Temperature Alarm Threshold.

Use the SMB write word to write this word data:

SMB	Dir	Offset	Value	Description
Write word	>	0	SA	Slave address
	>	1	0xBE	Command code
	>	2	0-255	Low byte data
	>	3	0-255	High byte data

Data format is as follows:

Bit	Description
7..0	Temperature Alarm Threshold. Unsigned 8-bit data, the LSB is 1°C. If MCU detects any of the backplane temperature (Temperature 0~7) is higher than the threshold, the MCU triggers a temperature alarm. The threshold range is between 0 and 110
15..8	Reserved.

### \*Write to Default Threshold (command 0xC0)

Writes to Default Threshold.

Use the SMB write word to write this command:

SMB	Dir	Offset	Value	Description
Write word	>	0	SA	Slave address
	>	1	0xC0	Command code
	>	2	0-255	N/A
	>	3	0-255	N/A

With default thresholds as follows:

Default Thresholds	
Target Chassis Temperature	50
5V Alarm Threshold	+5%
3.3V Alarm Threshold	+5%
+12V Alarm Threshold	+5%
-12V Alarm Threshold	+5%
Fan Speed Alarm Threshold	800
Temperature Alarm Threshold	70

### \*Reset MCU (command 0xC2)

Resets the MCU.

Use the SMB write word to write this command

SMB	Dir	Offset	Value	Description
Write word	>	0	SA	Slave address
	>	1	0xC2	Command code
	>	2	0-255	N/A
	>	3	0-255	N/A



**\*Write Fan Speed Mode (command 0xC4)**

Writes Fan Speed Mode.

Use the SMB write word to write this word data

SMB	Dir	Offset	Value	Description
Write word	>	0	SA	Slave address
	>	1	0xBE	Command code
	>	2	0-255	Low byte data
	>	3	0-255	High byte data

Data format is as follows:

Bit	Description
15..0	Write Fan Speed Mode 0: Auto 1: Full Speed 2: Low Speed

This page intentionally left blank.

# Appendix A - PMK-1524 Monitor Kit

The PMK-1524 is a 15" LCD display with touch screen/104-key industrial keyboard with touchpad kit, optionally available to accompany the PXES-2590. Specifications, assembly, installation, and use of the PMK-1524 are detailed here.

## A.1 Overview

- ▶ Aluminum construction
- ▶ 15" LCD display with touch screen
- ▶ Detachable 104-key industrial keyboard with touchpad
- ▶ 2 button release collapses keyboard to protect LCD monitor for transport
- ▶ VGA and USB connectors



Figure A-1: PMK-1524

A	Keyboard latch
B	VGA connector
C	USB connector

D	RJ45 connector and cable for keyboard & touch pad
E	Touch screen display
F	104-key keyboard, English
G	Touch pad and controls
H	OSD menu controls
I	Keyboard release

**Table A-1: PMK-1524 Legend**

## A.2 Specifications

<b>Display</b>	
Type	LCD touch screen
Maximum resolution	1024 ×768
Brightness	250 nits
Color	16.2M colors
Control	OSD (On screen display)
Connectivity	VGA

<b>Input</b>	
Keyboard	104-key, English
Mouse	Touchpad
Key lifetime	8 million cycles

<b>Physical</b>	
Dimensions	407 X 295 X 66 mm (16.02 X 11.61 X 2.60 in)
Weight	7.15 kg

### A.3 Package Contents

Before unpacking, check the shipping carton for any damage. If the shipping carton and/or contents are damaged, inform your dealer immediately. Retain the shipping carton and packing materials for inspection. Obtain authorization from your dealer before returning any product to ADLINK.

Please ensure that the following items are included in the package.

- ▶ PMK-1524
- ▶ Software CD
- ▶ VGA cable
- ▶ USB cable

If any of these items are missing or damaged, contact the dealer from whom you purchased the product. Save the shipping materials and carton in case you want to ship or store the product in the future.



Do not install or apply power to equipment that is damaged or missing components. Retain the shipping carton and packing materials for inspection. Please contact your ADLINK dealer/vendor immediately for assistance and obtain authorization before returning any product.

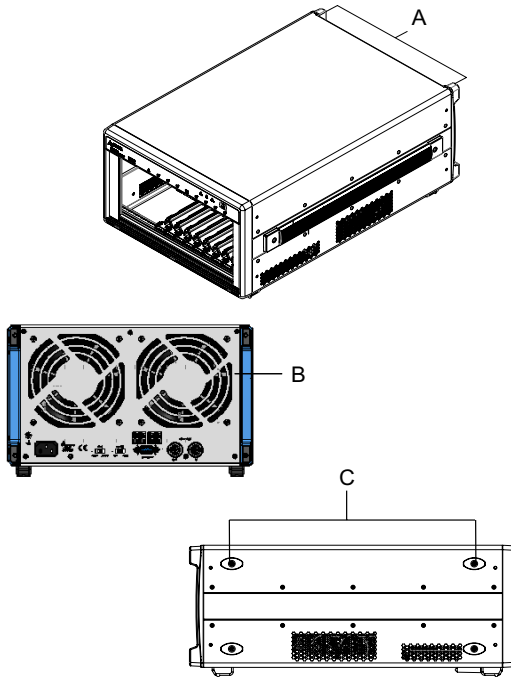
---

## A.4 Installing the PMK-1524



NOTE:

Assembly requires Torx T8 and Phillips No. 0 screwdrivers.



**Figure A-2: PXES-2590 Chassis Schematic**

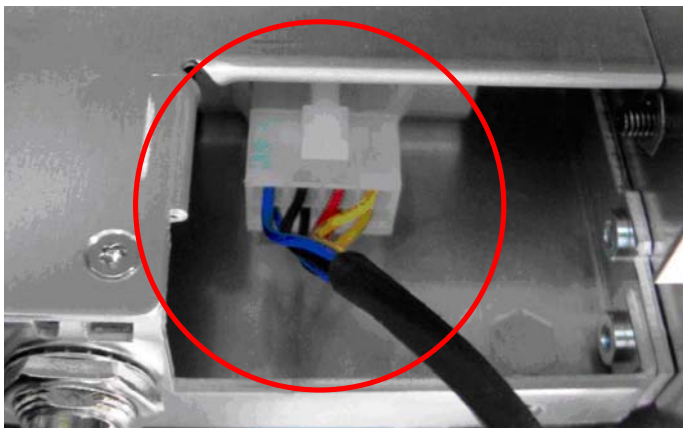
A	Bumpers
B	Rear Panel
C	Top Rubber Feet

**Table A-2: PXES-2590 Chassis Schematic Legend**

1. Remove the two bumpers
2. Remove the 11 screws from the periphery of the rear panel, as shown (do not remove the eight screws [four each] securing the two fans)



3. Remove the panel
4. Disconnect the cooling fan power cable, as shown



5. Remove the top two rubber feet from the left side of the chassis
6. Remove 5 screws from each side of the top cover
7. Slide the top cover backward as shown and remove





- Slide the PMK-1524 into the top of the chassis, ensuring that the positioning flange is securely received in the corresponding channel, as shown



- Replace 5 screws in each side of the chassis

10. Connect the PMK-1524 power cable, as shown



11. Reconnect the cooling fan power cable

12. Replace the rear panel on the chassis and fasten the 11 screws

13. Replace the rubber feet

14. Replace the two bumpers

## A.5 Connecting the PMK-1524

The provided VGA and USB cables connect the PMK-1524 to the embedded controller of the PXES-2590, and the touch panel and keyboard connect to the RJ45 port, as shown.



Figure A-3: PMK-1524 Connection to PXES-2590



NOTE:

DVI to VGA adapter may be required, depending on display interface

---

## A.5.1 Keyboard Detachment

The PMK-1524 keyboard can be detached from the main unit by simultaneously sliding the two keyboard releases outward, as shown.

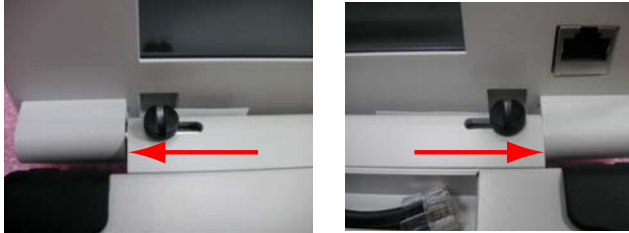


Figure A-4: PMK-1524 Keyboard Detachment

## A.6 Driver Installation

Drivers must be installed prior to use, as follows

1. Utilizing an external CD drive, run the included Software CD

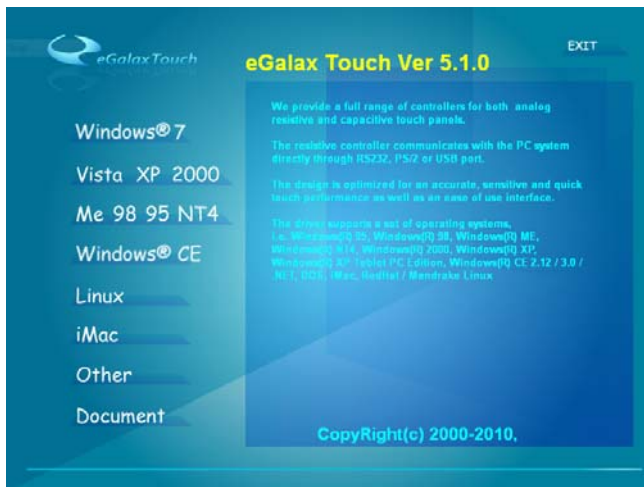
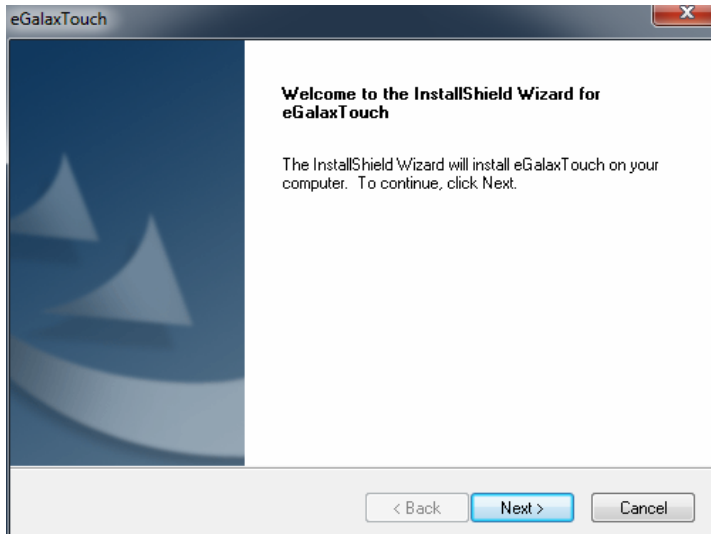


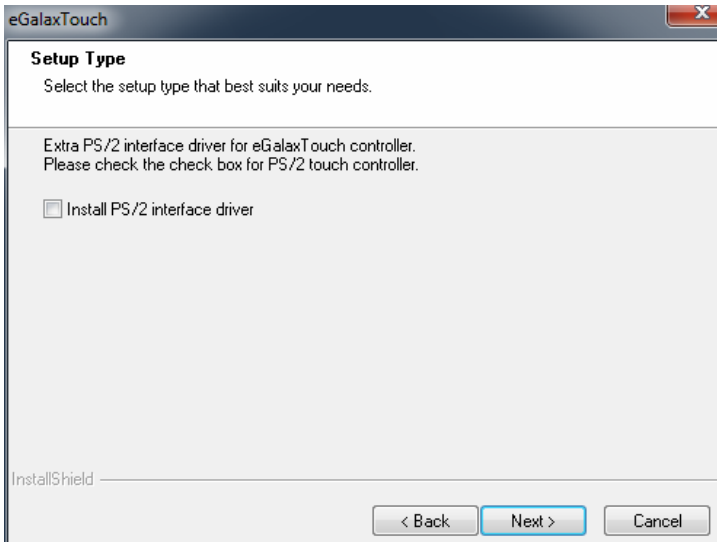
Figure A-5: Driver Installation Introduction

2. Follow the steps for installation, as directed

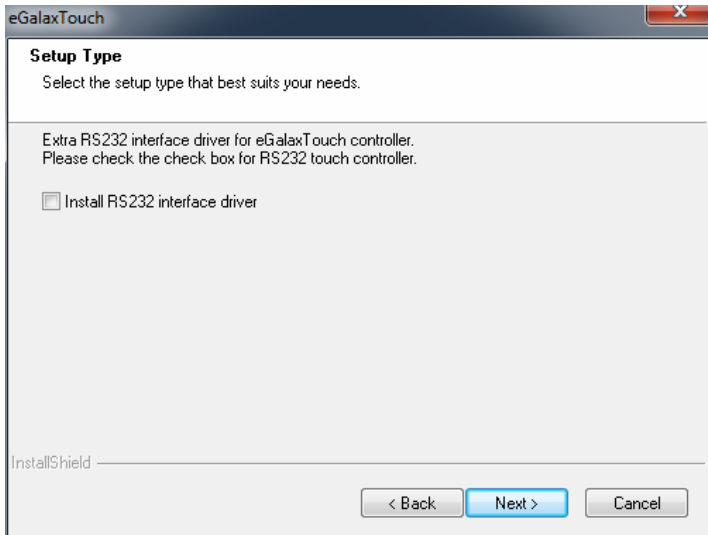


**Figure A-6: Installation Start**

3. When prompted, decline to install the PS/2 and RS232 interface drivers and do not detect Support Multi-Monitor System, as shown.

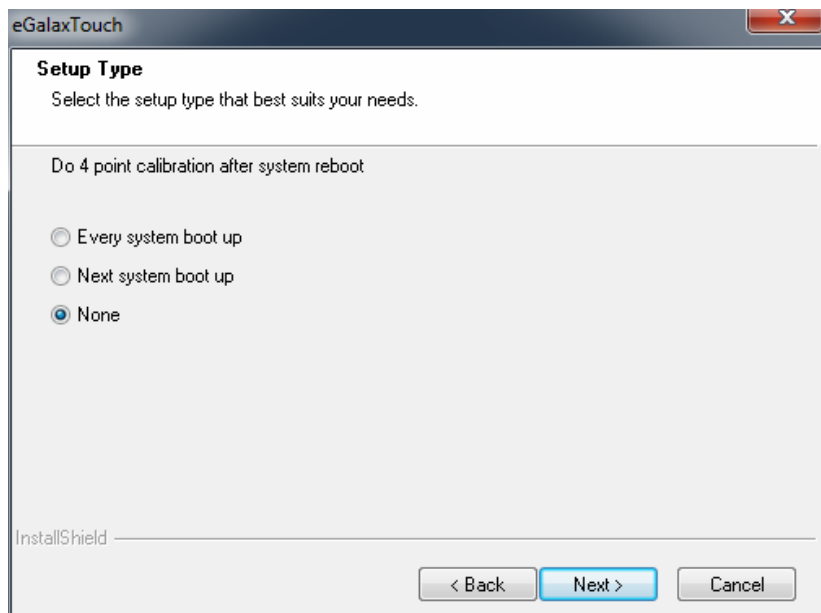


**Figure A-7: Interface Selection 1**



**Figure A-8: Interface Selection 1**

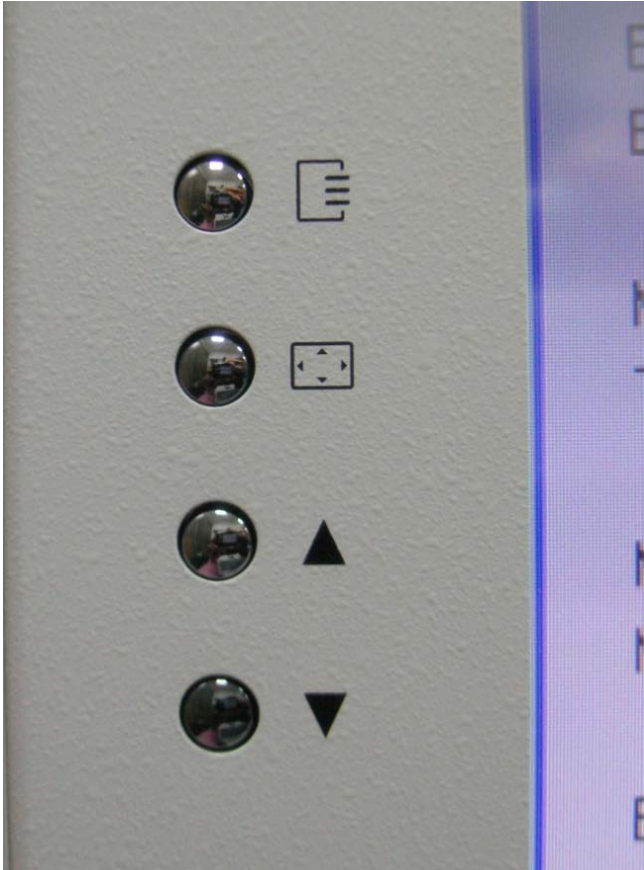
4. Once installation is complete, execute 4-point calibration



**Figure A-9: 4-point Calibration Setup**



## A.7 OSD Controls and Menu



**Figure A-10: OSD Controls**

OSD controls, from top to bottom, are:

- ▶ Menu
- ▶ Exit/Auto Adjust
- ▶ Right
- ▶ Left

## **A.7.1 OSD Menu**

- ▶ Brightness
- ▶ Contrast
- ▶ Horizontal Position
- ▶ Vertical Position
- ▶ Color
  - ▷ Auto Color
  - ▷ Temperature
- ▶ Image
  - ▷ Auto Adjust
  - ▷ Horizontal Width
  - ▷ Focus
- ▶ Languages
  - ▷ English
  - ▷ 中文
- ▶ Tools
  - ▷ Recall
  - ▷ Sharpness
  - ▷ OSD Time
  - ▷ OSD Position Horizontal
  - ▷ OSD Position Vertical

# Appendix B - Troubleshooting and Maintenance

This Appendix describes basic troubleshooting techniques, as well as instructions for the maintenance of the PXES-2590 chassis.

## B.1 Installation Problems

Inability to start the system frequently results from incorrect installation of the system controller, peripheral modules, and other components. Before starting the system, please ensure that:

- ▶ The system controller is properly installed and secured
- ▶ All peripheral modules are properly seated on the slots
- ▶ All cables are properly connected to the system controller and peripheral modules
- ▶ All installed peripheral modules are compatible for use in the chassis
- ▶ The power cord is securely plugged into the chassis power connector and power outlet/wall socket/power strip

If the system fails to start when all installation conditions are met, remove all installed peripheral modules and try again. If the system starts normally, instal one peripheral module at a time followed by powering up. You may also try installing the modules into different slots until the desired result is obtained

## B.2 Basic Troubleshooting

Problem	Ensure that:
System fails to power up	<ul style="list-style-type: none"> <li>▶ The power cord is securely plugged into the chassis power connector and wall socket/power strip</li> <li>▶ The wall socket/power strip is live</li> <li>▶ The main power switch on the back of the chassis is turned on</li> <li>▶ The standby power button on the chassis front panel is turned on</li> </ul>
No video output in the external display	<ul style="list-style-type: none"> <li>▶ The external display is functioning properly</li> <li>▶ Display settings support external video.</li> </ul>
Power LED (blue) is blinking	<ul style="list-style-type: none"> <li>▶ There is no short circuit by removing all PXI modules (PXI controller and peripheral modules)</li> </ul> <p>If the signal persists, contact your dealer for further assistance</p>
Fan LED (green) is blinking	<ul style="list-style-type: none"> <li>▶ The fan is unobstructed</li> </ul> <p>If the signal persists, contact your dealer for further assistance.</p>
Temperature LED (amber) is blinking	<ul style="list-style-type: none"> <li>▶ Airflow from the outlet apertures is unobstructed and steady; if not, ensure that adequate clearance for the intake apertures is provided</li> </ul> <p>If the temperature of exhausted air is normal (below 50°C) but the temperature LED is still blinking, contact your dealer for further assistance.</p>

## **B.3 Maintenance**

### **B.3.1 Handling the Chassis**

The PXES-2590 is designed for both rack-mount and benchtop use. When transporting or carrying the chassis, it is recommended that the handle be used, being designed to support the weight of the chassis for superior portability and balance.

The PXES-2590 weighs 8.8 kg. Please be careful when moving the chassis to avoid any possible injury.

### **B.3.2 Cleaning the Exterior**

Make sure that the system is turned off before cleaning the chassis exterior. Wipe the exterior with a clean cloth starting from areas that easily accumulate dust or dirt such as the area in and around the chassis and power supply air intake apertures.

### **B.3.3 Power Requirements**

Make sure that the power cord is in good condition before plugging it into the system. It is important to check the reliability of the power source. The PXES-2590 power supply is capable of handling 100 to 240 V AC within the 50 Hz to 60 Hz range. Do not connect the PXES-2590 to an already overloaded circuit.

This page intentionally left blank.

# Important Safety Instructions

For user safety, please read and follow all **instructions**, **WARNINGS**, **CAUTIONS**, and **NOTES** marked in this manual and on the associated equipment before handling/operating the equipment.

- ▶ Read these safety instructions carefully.
- ▶ Keep this user's manual for future reference.
- ▶ Read the specifications section of this manual for detailed information on the operating environment of this equipment.
- ▶ When installing/mounting or uninstalling/removing equipment:
  - ▷ Turn off power and unplug any power cords/cables.
- ▶ To avoid electrical shock and/or damage to equipment:
  - ▷ Keep equipment away from water or liquid sources;
  - ▷ Keep equipment away from high heat or high humidity;
  - ▷ Keep equipment properly ventilated (do not block or cover ventilation openings);
  - ▷ Make sure to use recommended voltage and power source settings;
  - ▷ Always install and operate equipment near an easily accessible electrical socket-outlet;
  - ▷ Secure the power cord (do not place any object on/over the power cord);
  - ▷ Only install/attach and operate equipment on stable surfaces and/or recommended mountings; and,
  - ▷ If the equipment will not be used for long periods of time, turn off and unplug the equipment from its power source.

- ▶ Never attempt to fix the equipment. Equipment should only be serviced by qualified personnel.
  - ▶ A Lithium-type battery may be provided for uninterrupted, backup or emergency power.
- 



Risk of explosion if battery is replaced with an incorrect type; please dispose of used batteries appropriately.

---

- ▶ Equipment must be serviced by authorized technicians when:
  - ▷ The power cord or plug is damaged;
  - ▷ Liquid has penetrated the equipment;
  - ▷ It has been exposed to high humidity/moisture;
  - ▷ It is not functioning or does not function according to the user's manual;
  - ▷ It has been dropped and/or damaged; and/or,
  - ▷ It has an obvious sign of breakage.



# Getting Service

Contact us should you require any service or assistance.

## **ADLINK Technology, Inc.**

Address: 9F, No.166 Jian Yi Road, Zhonghe District  
New Taipei City 235, Taiwan  
新北市中和區建一路 166 號 9 樓  
Tel: +886-2-8226-5877  
Fax: +886-2-8226-5717  
Email: [service@adlinktech.com](mailto:service@adlinktech.com)

## **Ampro ADLINK Technology, Inc.**

Address: 5215 Hellyer Avenue, #110, San Jose, CA 95138, USA  
Tel: +1-408-360-0200  
Toll Free: +1-800-966-5200 (USA only)  
Fax: +1-408-360-0222  
Email: [info@adlinktech.com](mailto:info@adlinktech.com)

## **ADLINK Technology (China) Co., Ltd.**

Address: 上海市浦东新区张江高科技园区芳春路 300 号 (201203)  
300 Fang Chun Rd., Zhangjiang Hi-Tech Park,  
Pudong New Area, Shanghai, 201203 China  
Tel: +86-21-5132-8988  
Fax: +86-21-5132-3588  
Email: [market@adlinktech.com](mailto:market@adlinktech.com)

## **ADLINK Technology Beijing**

Address: 北京市海淀区上地东路 1 号盈创动力大厦 E 座 801 室(100085)  
Rm. 801, Power Creative E, No. 1, B/D  
Shang Di East Rd., Beijing, 100085 China  
Tel: +86-10-5885-8666  
Fax: +86-10-5885-8625  
Email: [market@adlinktech.com](mailto:market@adlinktech.com)

## **ADLINK Technology Shenzhen**

Address: 深圳市南山区科技园南区高新南七道 数字技术园  
A1 栋 2 楼 C 区 (518057)  
2F, C Block, Bldg. A1, Cyber-Tech Zone, Gao Xin Ave. Sec. 7,  
High-Tech Industrial Park S., Shenzhen, 518054 China  
Tel: +86-755-2643-4858  
Fax: +86-755-2664-6353  
Email: [market@adlinktech.com](mailto:market@adlinktech.com)

## **ADLINK Technology (Europe) GmbH**

Address: Nord Carree 3, 40477 Duesseldorf, Germany  
Tel: +49-211-495-5552  
Fax: +49-211-495-5557  
Email: [emea@adlinktech.com](mailto:emea@adlinktech.com)

**ADLINK Technology, Inc. (French Liaison Office)**

Address: 15 rue Emile Baudot, 91300 Massy CEDEX, France  
Tel: +33 (0) 1 60 12 35 66  
Fax: +33 (0) 1 60 12 35 66  
Email: france@adlinktech.com

**ADLINK Technology Japan Corporation**

Address: 〒101-0045 東京都千代田区神田鍛冶町 3-7-4  
神田 374 ビル 4F  
KANDA374 Bldg. 4F, 3-7-4 Kanda Kajicho,  
Chiyoda-ku, Tokyo 101-0045, Japan  
Tel: +81-3-4455-3722  
Fax: +81-3-5209-6013  
Email: japan@adlinktech.com

**ADLINK Technology, Inc. (Korean Liaison Office)**

Address: 서울시 서초구 서초동 1675-12 모인터빌딩 8 층  
8F Mointer B/D, 1675-12, Seocho-Dong, Seocho-Gu,  
Seoul 137-070, Korea  
Tel: +82-2-2057-0565  
Fax: +82-2-2057-0563  
Email: korea@adlinktech.com

**ADLINK Technology Singapore Pte. Ltd.**

Address: 84 Genting Lane #07-02A, Cityneon Design Centre,  
Singapore 349584  
Tel: +65-6844-2261  
Fax: +65-6844-2263  
Email: singapore@adlinktech.com

**ADLINK Technology Singapore Pte. Ltd. (Indian Liaison Office)**

Address: 1st Floor, #50-56 (Between 16th/17th Cross) Margosa Plaza,  
Margosa Main Road, Malleswaram, Bangalore-560055, India  
Tel: +91-80-65605817, +91-80-42246107  
Fax: +91-80-23464606  
Email: india@adlinktech.com

**ADLINK Technology, Inc. (Israeli Liaison Office)**

Address: 6 Hasadna St., Kfar Saba 44424, Israel  
Tel: +972-9-7446541  
Fax: +972-9-7446542  
Email: israel@adlinktech.com